



VH5/VH6 series EtherCAT communication
User manual

Wuxi XINJE Electric Co., Ltd.

Data No.: INV C 08 20220623 1.1



Basic description

- ◆ Thank you for purchasing Xinje VH5 series frequency converter. Please read this product manual carefully before carrying out relevant operation.
- ◆ The manual mainly provides users with relevant guidance and instructions for the correct use and maintenance of the frequency converter. The manual involves the functions of the frequency converter communication expansion card, usage, installation and maintenance, etc.
- ◆ The contents in the manual are only applicable to the inverter products of Xinje company.

Notice to users

This manual is suitable for the following users

- ◆ The installation personnel of frequency converter
- ◆ Engineering and technical personnel (electrical engineer, electrical operator, etc.)
- ◆ The designer

Before the above personnel operate or debug the inverter, please carefully read the chapter of safety precautions in this manual.

Statement of responsibility

- Although the contents of the manual have been carefully checked, errors are inevitable, and we can't guarantee complete consistency.
- We will often check the contents of the manual and correct them in subsequent versions. We welcome your valuable comments.
- Please understand that the contents described in the manual are subject to change without notice.

Contact us

If you have any questions about the use of this product, please contact the agent and office purchasing the product, or directly contact Xinje company.

- Tel: 400-885-0136
- Fax: 0510-85111290
- Address: No.816, Jianzhu West Road, Binhu District, Wuxi City, Jiangsu Province, China
- Code: 214072
- Website: www.xinje.com

WUXI XINJE ELECTRIC CO., LTD. All rights reserved

This material and its contents shall not be copied, transmitted or used without explicit written permission. Violators shall be liable for the losses caused. All rights provided in the patent license and registration including utility modules or designs are reserved.

March, 2021

Catalog

Catalog	3
1. Product confirmation	5
2. Summary	6
3. Product characteristics	6
4. Communication card components	7
4.1 VH5-CC100 communication card components & indicator description.....	7
4.2 VH6-CC100communication card components & indicator description.....	8
5. Installation	9
5.1 Install VH5-CC100 communication card.....	9
5.2 Install VH6-CC100 communication card.....	10
6. CoE Object dictionary	11
6.1 Object dictionary area assignment.....	11
6.2 COE communication area.....	11
6.3 VFD Internal parameter mapping area (manufacturer defined area).....	14
6.4 Independent Protocol.....	15
6.5 CiA402 object(Driver profile area).....	16
7. State control	17
7.1 VFD status control.....	17
7.1.1 state machine.....	17
7.1.2 Status description.....	18
7.1.3 Control command.....	18
7.1.4 Status.....	18
7.2 Operating mode.....	19
7.2.1 Speed mode.....	19
7.2.2 Torque mode.....	19
8. Independent protocol object	20
9. CiA402 protocol object	22
10. EtherCAT use case	26
10.1 XINJE XDH series PLC and VH5/VH6.....	26
10.1.1 System topology.....	26
10.1.2 Physical wiring.....	26
10.1.3 System configuration.....	26
10.1.4 Control under CIA 402 protocol and Independent protocol.....	29

10.1.5 Instruction read / write	33
10.2 Omron series PLC and VH5/VH6(CiA402 protocol)	35
10.2.1 System configuration	35
10.2.2 Parameter setting	35
10.2.3 Setup steps	35
10.3 Beckhoff series PLC (TWINCAT) and VH5/VH6	45
10.3.1 System configuration	45
10.3.2 Parameter setting	45
10.3.3 Setup steps	45
10.4 Inovance AM600 (CODESYS) and VH5/VH6	50
10.4.1 System configuration	50
10.4.2 Parameter setting	50
10.4.3 Setup steps	50
10.5 Inovance H5U and VH5/VH6	58
10.5.1 System configuration	58
10.5.2 Parameter setting	58
10.5.3 Setup steps	58
10.6 KEYENCE PLC KV 7300 and VH5/VH6	64
10.6.1 System configuration	64
10.6.2 Parameter setting	64
10.6.3 Setup steps	64
11. EtherCAT communication alarm code	71

1. Product confirmation

Thank you for using XINJE VH5 / VH6 series frequency converter and selecting EtherCAT expansion card.

Please confirm the following when receiving the product:

- Check whether the Ethercat expansion card is damaged.
- Confirm whether the received card is correct through the label on the board, refer to Fig1.
- Confirm whether the package is complete. Refer to Table 1.
- If the card is damaged, the model is wrong, or there are omissions in the package, please contact the supplier or salesman immediately.
- Please download the XML file of this card on the website: www.xinje.com, file name: VHX-CC100.xml.

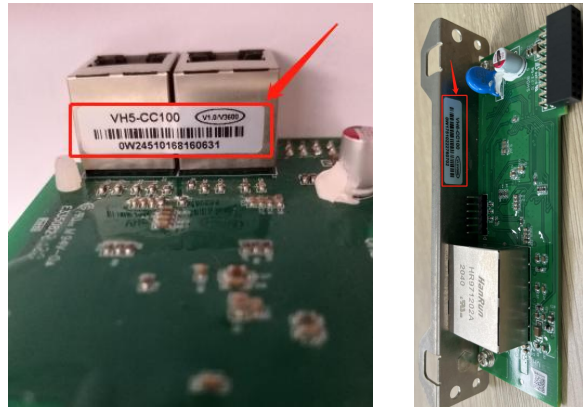





Fig. 1 Nameplate label location

Table 1 Package

Model	Content	Photo	Quantity
VH5-CC100	Communication card		1
	Screw and bracket		1
VH6-CC100	Communication card		1

2. Summary

This manual provides functional specifications, installation, basic operation and settings, as well as a brief introduction to the contents of EtherCAT protocol. To ensure the correct installation and operation of this product, please carefully read this manual and the communication protocol of the frequency converter before using this communication card.

This manual is only used as the VHX-CC100 operation guide and related instructions. The details of EtherCAT protocol are not introduced here. If readers want to know more about EtherCAT protocol, please refer to relevant professional articles or books.

This EtherCAT communication card supports two kinds of reading and writing process quantities, one is through PDO, and the other is through SDO to read and write the object dictionary defined by the manufacturer.

3. Product characteristics

■ Supported functions

Support EtherCAT COE 402 protocol

■ Supported services

- Support PDO
- Support SDO
- Support the object dictionary defined by the manufacture
- Support SDO to read and write the function code of VFD

■ Supported EtherCAT Synchronization cycle

Item	Supported specifications
Synchronization cycle	250us
	1ms
	2ms
	4ms

■ SDO/PDO data description

SDO(Service Data Object) is used to transmit aperiodic communication data. The master station reads and writes data in the object dictionary , and can set the objects and monitor various states of the slave station. The response to the read / write action to the SDO takes time. Objects refreshed with PDO should not be refreshed with SDO, but overwritten with the value of PDO.

PDO(Process Data Object) is used to transmit periodic communication data.

The data in PDO area can realize the real-time change of VFD data by the master station and the real-time reading of periodic data interaction.

The communication address of the data is directly configured by the VFD. It mainly includes the following contents:

Master station send PDO data(RxPDO 0x1600)								
Fixed RxPDO								Variable RxPDO
Controlword 6040h	vl target velocity 6042h	Modes of operation 6060h	Target position 607A h (reserved)		Target torque 6071h		Functional parameters of VFD can be changed in real time	
RxPDO1	RxPDO2	RxPDO3	RxPDO4	RxPDO5	RxPDO6	RxPDO7	RxPDO8	None
VFD corresponding PDO data(TxPDO 0x1a00)								
Fixed TxPDO								Variable TxPDO
Statusword 6041 h	Velocity actual value 606C h	Mode of operation display 6061 h	Torque actual value 6077 h	Position actual value 6064 h	vl target demand 6043 h	Error code 603Fh	vl target actual value 6044h	Functional parameters of VFD can be changed in real time
TxPDO1	TxPDO2	TxPDO3	TxPDO4	TxPDO5	TxPDO6	TxPDO7	TxPDO8	TxPDO9~TxPDO12

Note: RxPDO and TxPDO can be configured with 12 at most. RxPDO cannot be added. 8 TxPDOs can be fixed and 4 TxPDOs can be added.

4. Communication card components

4.1 VH5-CC100 communication card components & indicator description

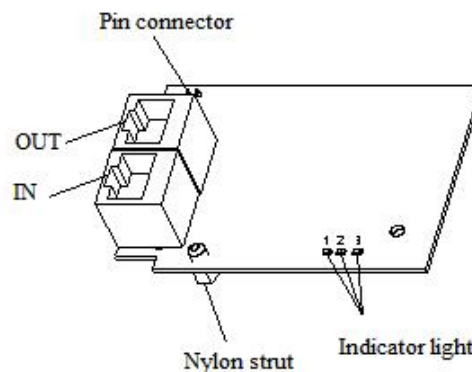

The expansion card has three LED lights, as shown in the figure .

The status indicators in the figure are error indicator, operation indicator and VFD communication status indicator from left to right. The descriptions are as follows:

Type	Status	Description
Error indicator	Normally OFF	No error
	OFF 0.2s ON 0.2s flashing	Pre-OP fault status
	OFF 1s ON 1s flashing	Safe-OP fault status
	Normally ON	OP fault status
Operation indicator	Normally OFF	Init status
	OFF 0.2s ON 0.2s flashing	Pre-OP status
	OFF 1s ON 1s flashing	Safe-OP status
	Normally ON	OP status

VFD communication status indicator	Normally OFF	The expansion card is disconnected from the frequency converter
	1Hz flashing	The connection between the expansion card and the frequency converter is normal
	Normally ON	The expansion card is establishing connection with the frequency converter

4.2 VH6-CC100 communication card components & indicator description

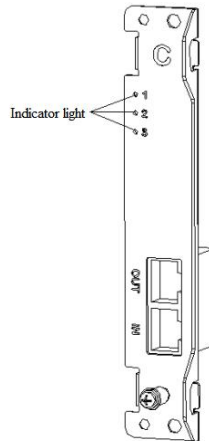

The status indicators in the figure are VFD communication status indicator , operation indicator and the error indicator from top to bottom. The descriptions are as follows:

Type	Status	Description
VFD communication status indicator	Normally OFF	The expansion card is disconnected from the frequency converter
	1Hz flashing	The connection between the expansion card and the frequency converter is normal
	Normally ON	The expansion card is establishing connection with the frequency converter
Operation indicator	Normally OFF	Init status
	OFF 0.2s ON 0.2s flashing	Pre-OP status
	OFF 1s ON 1s flashing	Safe-OP status
	Normally ON	OP status
Error indicator	Normally OFF	No error
	OFF 0.2s ON 0.2s flashing	Pre-OP fault status
	OFF 1s ON 1s flashing	Safe-OP fault status
	Normally ON	OP fault status

5. Installation

5.1 Install VH5-CC100 communication card

1. Disconnect all power inputs of frequency converters to ensure that the internal voltage of the frequency converter is safe.
2. Disassemble the frequency converter cover plate and find the control board.
3. Install the hexagon stud at the corresponding position of the board, and tighten the M3 single head hexagon stud on the drive plate. As shown in the following figure:

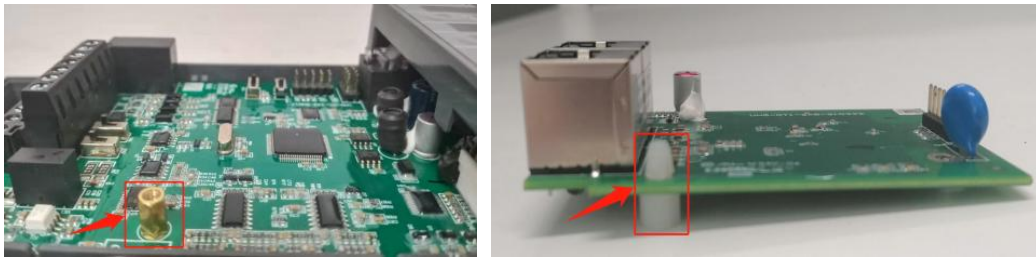

4. Align the communication card pin with the expansion card slot of the control board and insert it firmly.
 5. Tighten M3 screws.
 6. Install the frequency converter cover plate.
 7. Connect and fix the communication line.
- Note:** Hot plugging is prohibited.

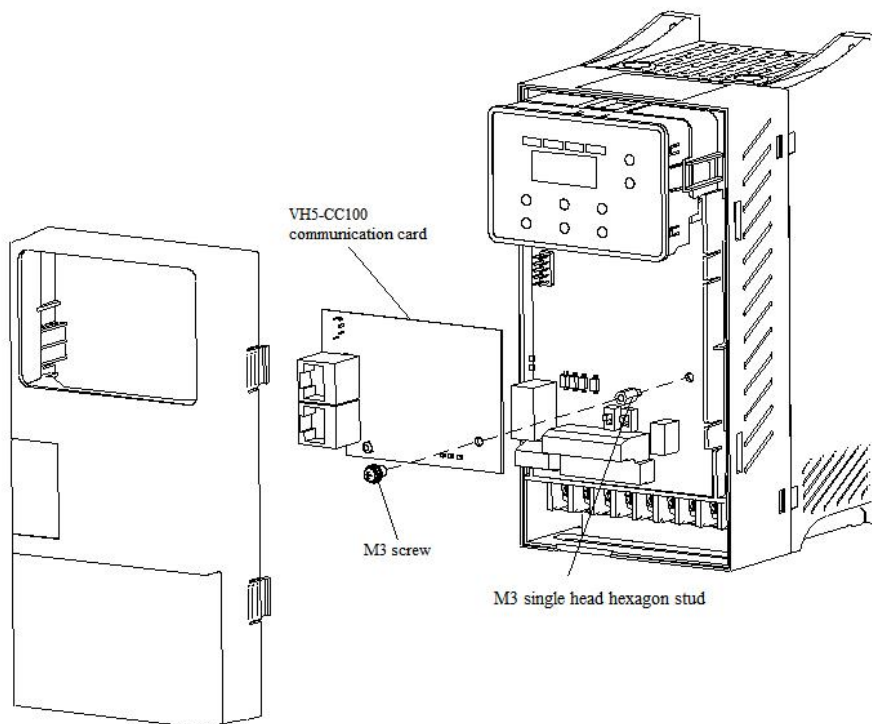

5.2 Install VH6-CC100 communication card

1. Disconnect all power inputs of VFD to ensure that the internal voltage of the frequency converter is safe.
2. Remove the C card cover plate of the VFD.
3. Align the communication card pin with the control board expansion card slot and insert it firmly.
4. Tighten M3 screws.
5. Connect and fix the communication line.

Note: Hot plugging is prohibited.

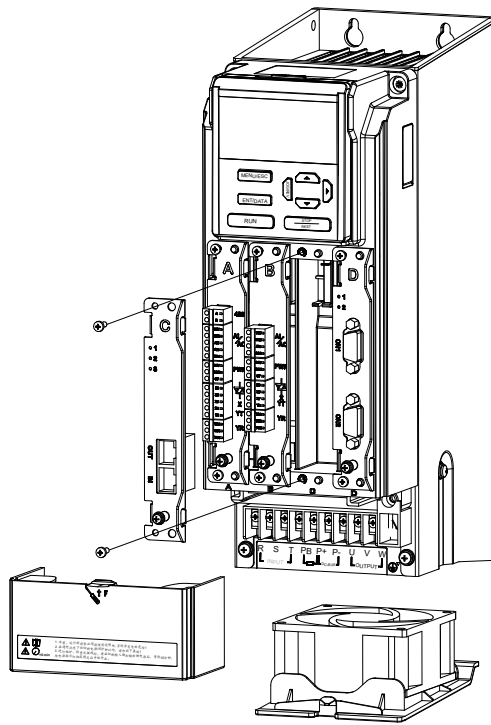

6. CoE Object dictionary

6.1 Object dictionary area assignment

CoE Object dictionary		VHX-CC100 object dictionary	
Index	Content	Index	Content
0000h~0FFFh	Data type area	0000h~0FFFh	Data type area
1000h~1FFFh	COE communication area	1000h~1C33h	DS301 object dictionary (CANopen protocol communication area)
2000h~4FFFh	Factory parameter display and setting area	2000h~4FFFh	VFD Internal parameter mapping area (manufacturer defined area)
5000h~5FFFh	Independent Protocol area	5000h~5200h	Independent motion control (manufacturer defined area)
6000h~9FFFh	Device CiA402 protocol area	6000h~6502h	CiA402object(Driver profile area)
		7000h~9FFFh	Reserved
A000~FFFFh	Reserved	A000h~FFFFh	Reserved

The object dictionary of EtherCAT bus is all in the device description file, i.e. XML file. The XML file of VH5 and VH6 EtherCAT expansion card is: VHX-CC.xml.

6.2 COE communication area

Index	Sub-index	Name	Data type	Access
1000h	-	Device type	UINT32	RO
1001h	-	Error register	UINT8	RO
1008h	-	Manufacture device name	STRING	-
1009h	-	Manufacture hardware version	STRING	-
100Ah	-	Manufacture software version	STRING	-
1018h	-	Identity object	-	-
	00	Number of entries	UINT8	RO
	01	Vendor ID	UINT32	RO
	02	Product code	UINT32	RO
	03	Revision number	UINT32	RO
	04	Serial number	UINT32	RO
1600h	-	Receive PDO mapping 1	-	-
	00	Number of entries	UINT8	RW
	01	1st receive PDO mapped	UINT32	RW
	02	2nd receive PDO mapped	UINT32	RW
	03	3rd receive PDO mapped	UINT32	RW
	04	4th receive PDO mapped	UINT32	RW

	11	11th receive PDO mapped	UINT32	RW
	12	12th receive PDO mapped	UINT32	RW
1601h	-	Receive PDO mapping 2	-	-
	00	Number of entries	UINT8	RW
	01	1st receive PDO mapped	UINT32	RW
	02	2nd receive PDO mapped	UINT32	RW

Index	Sub-index	Name	Data type	Access
	03	3rd receive PDO mapped	UINT32	RW
	04	4th receive PDO mapped	UINT32	RW

	11	11th receive PDO mapped	UINT32	RW
	12	12th receive PDO mapped	UINT32	RW
1602h	-	Receive PDO mapping 3	-	-
	00	Number of entries	UINT8	RW
	01	1st receive PDO mapped	UINT32	RW
	02	2nd receive PDO mapped	UINT32	RW
	03	3rd receive PDO mapped	UINT32	RW
	04	4th receive PDO mapped	UINT32	RW

	11	11th receive PDO mapped	UINT32	RW
12	12th receive PDO mapped	UINT32	RW	
1603h	-	Receive PDO mapping 4	-	-
	00	Number of entries	UINT8	RW
	01	1st receive PDO mapped	UINT32	RW
	02	2nd receive PDO mapped	UINT32	RW
	03	3rd receive PDO mapped	UINT32	RW
	04	4th receive PDO mapped	UINT32	RW

	11	11th receive PDO mapped	UINT32	RW
12	12th receive PDO mapped	UINT32	RW	
1A00h	-	Transmit PDO mapping 1	-	-
	00	Number of entries	UINT8	RW
	01	1st transmit PDO mapped	UINT32	RW
	02	2nd transmit PDO mapped	UINT32	RW
	03	3rd transmit PDO mapped	UINT32	RW
	04	4th transmit PDO mapped	UINT32	RW

	11	11th transmit PDO mapped	UINT32	RW
12	12th transmit PDO mapped	UINT32	RW	
1A01h	-	Transmit PDO mapping 2	-	-
	00	Number of entries	UINT8	RW
	01	1st transmit PDO mapped	UINT32	RW
	02	2nd transmit PDO mapped	UINT32	RW
	03	3rd transmit PDO mapped	UINT32	RW
	04	4th transmit PDO mapped	UINT32	RW

	11	11th transmit PDO mapped	UINT32	RW
12	12th transmit PDO mapped	UINT32	RW	
1A02h	-	Transmit PDO mapping 3	-	-
	00	Number of entries	UINT8	RW
	01	1st transmit PDO mapped	UINT32	RW
	02	2nd transmit PDO mapped	UINT32	RW
	03	3rd transmit PDO mapped	UINT32	RW
	04	4th transmit PDO mapped	UINT32	RW
...	

Index	Sub-index	Name	Data type	Access
	11	11th transmit PDO mapped	UINT32	RW
	12	12th transmit PDO mapped	UINT32	RW
1A03h	-	Transmit PDO mapping 4	-	-
	00	Number of entries	UINT8	RW
	01	1st transmit PDO mapped	UINT32	RW
	02	2nd transmit PDO mapped	UINT32	RW
	03	3rd transmit PDO mapped	UINT32	RW
	04	4th transmit PDO mapped	UINT32	RW

	11	11th transmit PDO mapped	UINT32	RW
	12	12th transmit PDO mapped	UINT32	RW
	1C00h	-	Sync manager communication type	-
01		Communication type sync manager 0	UINT8	RO
02		Communication type sync manager 1	UINT8	RO
03		Communication type sync manager 2	UINT8	RO
04		Communication type sync manager 3	UINT8	RO
1C12h	-	Sync manager channel 2	-	-
	00	Number of assigned PDOs	UINT8	RW
	01	PDO mapping object index of assigned RxPDO1	UINT16	RW
	02	PDO mapping object index of assigned RxPDO2	UINT16	RW
	03	PDO mapping object index of assigned RxPDO3	UINT16	RW
	04	PDO mapping object index of assigned RxPDO4	UINT16	RW
1C13h	-	Sync manager channel 3	-	-
	00	Number of assigned PDOs	UINT8	RW
	01	PDO mapping object index of assigned TxPDO1	UINT16	RW
	02	PDO mapping object index of assigned TxPDO2	UINT16	RW
	03	PDO mapping object index of assigned TxPDO3	UINT16	RW
	04	PDO mapping object index of assigned TxPDO4	UINT16	RW
1C32h	-	SM output parameter	-	-
	00	Number of sub-objects	UINT8	RO
	01	Synchronization Type	UINT16	RW
	02	Cycle time	UINT32	RO
	03	Shift time	UINT32	RW
	04	Sync modes supported	UINT16	RO
	05	Minimum cycle time	UINT32	RO
	06	Calc and copy Time	UINT32	RO
	08	Get cycle time	UINT16	RW
	09	Delay time	UINT32	RO
	10	Sync0 cycle time	UINT32	RW
	11	SM-Event Missed	UINT16	RO
	12	Cycle time too small	UINT16	RO
	32	Sync error	UINT8	RO
1C33h	-	SM input parameter	-	-
	00	Number of sub-objects	UINT8	RO
	01	Sync mode	UINT16	RW
	02	Cycle time	UINT32	RO
	04	Sync modes supported	UINT16	RO
	05	Minimum cycle time	UINT32	RO

Index	Sub-index	Name	Data type	Access
	06	Calc and copy Time	UINT32	RO
	08	Get cycle time	UINT16	RW
	09	Delay time	UINT32	RO
	10	Sync0 cycle time	UINT32	RW
	11	SM-Event Missed	UINT16	RO
	12	Cycle time too small	UINT16	RO
	32	Sync error	UINT8	RO

Note: Items marked with "-" in the table indicate that there are no related attributes in the object dictionary.

6.3 VFD Internal parameter mapping area (manufacturer defined area)

The object dictionary in the user-defined area of the manufacturer corresponds to the panel parameters of VFD one by one. Only Group U parameters of the object dictionary in this area can be TPDO mapped and can be read by PDO. Other object dictionaries can only be operated based on SDO.

Index	Sub-index	Parameter
2000h	00	P0-00
2001h	00	P0-01
2002h	00	P0-02
2003h	00	P0-03
...
201Ah	00	P0-26
2100h	00	P1-00
2101h	00	P1-01
2102h	00	P1-02
2103h	00	P1-03
...
2123h	00	P1-35
2200h	00	P2-00
2201h	00	P2-01
2202h	00	P2-02
2203h	00	P2-03
...
2246h	00	P2-70
2300h	00	P3-00
2301h	00	P3-01
2302h	00	P3-02
2303h	00	P3-03
...
2317	00	P3-23
2400	00	P4-00
2401	00	P4-01
2402	00	P4-02
2403h	00	P4-03

Index	Sub-index	Parameter
2900h	00	P9-00
2901h	00	P9-01
0902h	00	P9-02
2903h	00	P9-03
...
291Eh	00	P9-30
2A00h	00	PA-00
2A01h	00	PA-01
2A02h	00	PA-02
2A03h	00	PA-03
...
2A1Dh	00	PA-29
2B00h	00	PB-00
2B01h	00	PB-01
2B02h	00	PB-02
2B03h	00	PB-03
...
2B33h	00	PB-51
2C00h	00	PC-00
2C01h	00	PC-01
2C02h	00	PC-02
2C03h	00	PC-03
...
2C46	00	PC-70
2F00h	00	PF -00
2F01h	00	PF -01
2F02h	00	PF -02
2F03h	00	PF -03

Index	Sub-index	Parameter
...
241B	00	P4-27
2500h	00	P5-00
2501h	00	P5-01
2502h	00	P5-02
2503h	00	P5-03
...
2532	00	P5-50
2600h	00	P6-00
2601h	00	P6-01
2602h	00	P6-02
2603h	00	P6-03
...
2617h	00	P6-23
2700h	00	P7-00
2701h	00	P7-01
2702h	00	P7-02
2703h	00	P7-03
...
2750h	00	P7-80
2800h	00	P8-00
2801h	00	P8-01
2802h	00	P8-02
2803h	00	P8-03
...
2818h	00	P8-24

Index	Sub-index	Parameter
...
2F08h	00	PF -08
3000h	00	A0-00
3001h	00	A0-01
3002h	00	A0-02
3003h	00	A0-03
...
3009	00	A0-09
3100h	00	A1-00
3101h	00	A1-01
3102h	00	A1-02
3103h	00	A1-03
...
3115h	00	A1-21
3200h	00	A2-00
3201h	00	A2-01
3202h	00	A2-02
3203h	00	A2-03
...
3240h	00	A2-64
4000h	00	U0-00
4001h	00	U0-01
4002h	00	U0-02
4003h	00	U0-03
...
404Bh	00	U0-75

6.4 Independent Protocol

Index	Sub-index	Object Type	Name	Data Type	Access	PDO
5000	-	VAR	Command	UINT16	RW	YES
5010	-	VAR	Target speed	UINT16	RW	YES
5100	-	VAR	Status	UINT16	RO	YES
5110	-	VAR	Output frequency	UINT16	RO	YES
5200	-	RECORD	Communicate state	-	-	-
	01	VAR	Number of frame lost	UINT16	RO	NO
	02	VAR	Number of CRC errors	UINT16	RO	NO
	03	VAR	Number of rejects	UINT16	RO	NO
	04	VAR	Newest error cause	UINT16	RO	NO
	05	VAR	Newest error index	UINT16	RO	NO

	06	VAR	Cycle time	UINT16	RO	NO
--	----	-----	------------	--------	----	----

Note: the 5200hex is used to observe the communication status between the expansion card and the frequency converter and does not participate in the actual control.

6.5 CiA402 object(Driver profile area)

Index	Sub-index	Object Type	Name	Data Type	Access	PDO
603F	-	VAR	Error code	UINT16	RO	YES
6040	-	VAR	Control word	UINT16	RW	YES
6041	-	VAR	Status word	UINT16	RO	YES
6042	-	VAR	vl target velocity(0.01%)	INT16	RW	YES
6043	-	VAR	vl target demand	INT16	RO	YES
6044	-	VAR	vl target actual value	INT16	RO	YES
6046	-	RECORD	vl velocity acceleration			
	01	VAR	Lower limit frequency	UINT32	RW	NO
	02	VAR	Upper limit frequency	UINT32	RW	NO
6048	-	RECORD	vl velocity acceleration			
	01	VAT	Maximum output frequency	UINT32	RO	NO
	02	VAR	Acceleration time	UINT16	RW	NO
6049	-	RECORD	vl velocity deceleration			
	01	VAT	Maximum output frequency	UINT32	RO	NO
	02	VAR	Deceleration time	UINT16	RW	NO
605B	-	VAR	Shutdown option code	UINT16	RW	NO
605C	-	VAR	Disable operation option code	UINT16	RW	NO
605E	-	VAR	Fault reaction option code	UINT16	RW	NO
6060	-	VAR	Modes of operation	INT8	RW	NO
6061	-	VAR	Modes of operation display	INT8	RO	NO
6064	-	VAR	Position actual value	INT32	RO	YES
606C	-	VAR	Velocity actual value(reserved)	INT32	RO	YES
6071	-	VAR	Target torque	INT16	RW	YES
6077	-	VAR	Torque actual value	INT16	RO	YES
607A	-	VAR	Target position(reserved)	INT32	RW	YES
6502	-	VAR	Supported drive modes	UINT32	RO	NO

7. State control

7.1 VFD status control

7.1.1 State machine

The operation state transition of VFD is shown in the figure below. Each box represents a state, and the serial number 2-10,15 represents the state control command.

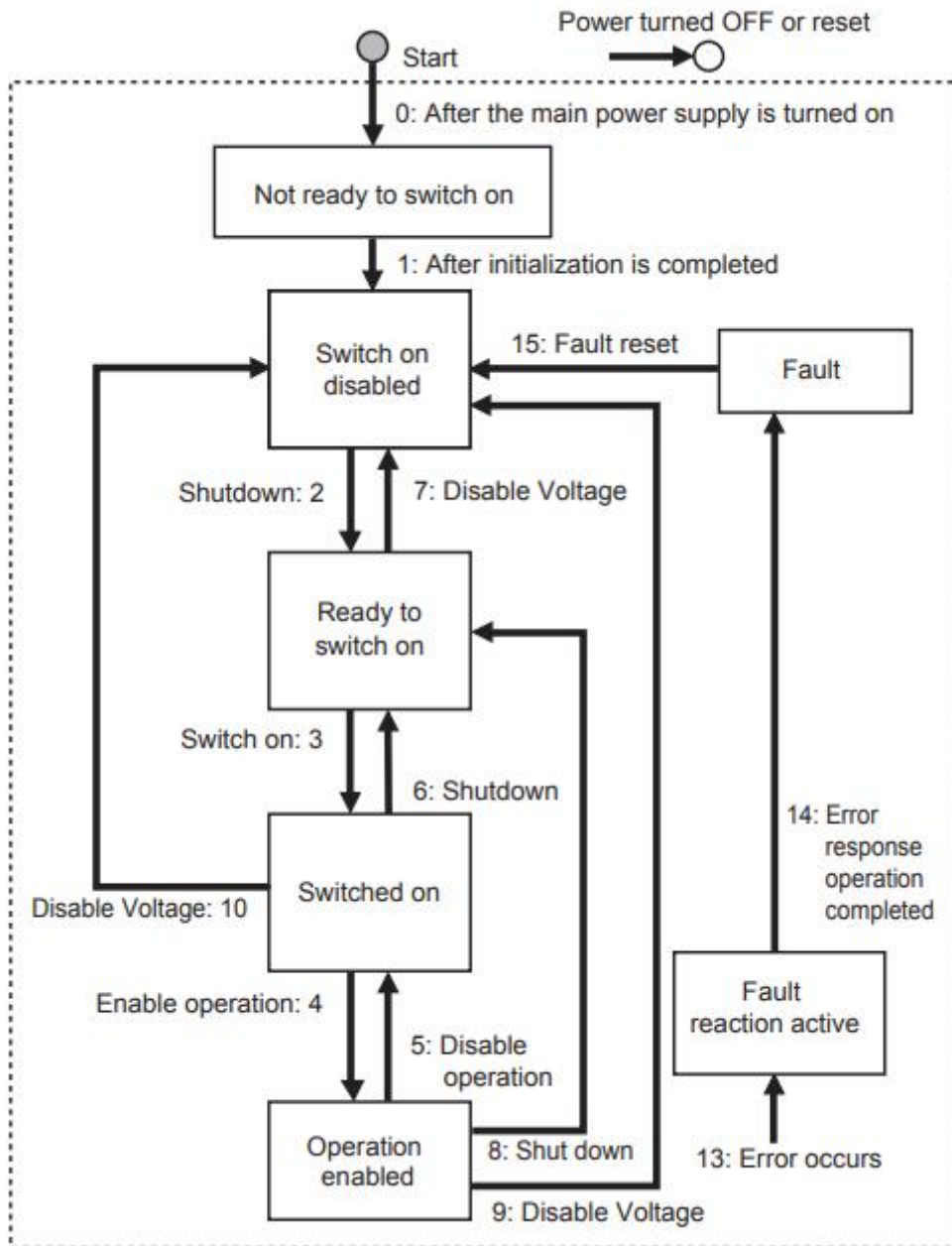

Note: quick stop command is not supported. If the master station executes quick stop command, it will execute the command of conversion 9 (free shutdown).

7.1.2 Status description

Status	Description
Not ready to switch on	Power on the power supply and execute the initialization procedure
Switch on disabled	Initialization end
Ready to switch on	Waiting to enter the Switch On state, the motor is not excited
Switch on	VFD is ready, main loop power supply is normal
Operation enabled	VFD can be controlled and work normally
Fault reaction active	Occur the error and the cause of the fault needs to be determined
Fault	Fault status

7.1.3 Control command

The status is controlled by the bit of the control command (Controlword 6040 h). The combined control table is as follows.

Command	Controlword					Transitions
	Bit7	Bit3	Bit2	Bit 1	Bit 0	
	Fault reset	Enable Operation	Quick Stop	Enable Voltage	Switch On	
Switch on	0	-	1	1	0	2,6,8
Switch on+ Enable operation	0	0	1	1	1	3
Disable voltage	-	1	1	1	1	3,4 (Automatic conversion)
Quick stop	-	-	-	0	-	7,9,10
Disable operation	-	0	1	1	1	5
Enable operation	-	1	1	1	1	4
Fault reset	0->1	-	-	-	-	15

7.1.4 Status

The bit combination of statusword (6041 hex) indicates the working status of the equipment, as shown in the following table:

Status	Bit 12 FC	Bit 9 RO	Bit 6 SOD	Bit5 QS	Bit 4 VE	Bit 3 F	Bit 2 OE	Bit 1 SO	Bit 0 RTSO
Not ready to switch on	1	1	0	0	-	0	0	0	0
Switch on disable	1	1	1	-	-	0	0	0	0
Ready to switch on	1	1	0	1	-	0	0	0	1
Switched on	1	1	0	1	1	0	0	1	1
Operation enabled	1	1	0	1	1	0	1	1	1
Fault reaction active	1	1	0	1	-	1	1	1	1
Fault	1	1	0	1	-	1	0	0	0

Note:

(1)FC = Follow command; RO = Remote; SOD = Switch on disabled; QS = Quick stop; VE = Voltage enabled; F = Fault; OE = Operation enabled; SO = Switched on; RTSO = Ready to switch on.

(2)"-" means no requirement, which may be 0 or 1. It does not participate in the judgment.

7.2 Operating mode

The operation mode supports speed mode and torque mode, which are set by parameter PF-00:

Speed mode: PF-00=0. Torque mode: PF-00=1.

The operation mode supported by the frequency converter is displayed by "Supported drive modes (6502 hex)".

This mode supports clock synchronization mode (DC sync) and periodic synchronization mode (SM sync).

Note: Mode switching can only be realized by setting variable frequency pf-00 parameters, which cannot be modified during operation.

Setting "modes of operation (6060 hex)" cannot switch the operation mode. The default is 6060h=2.

7.2.1 Speed mode

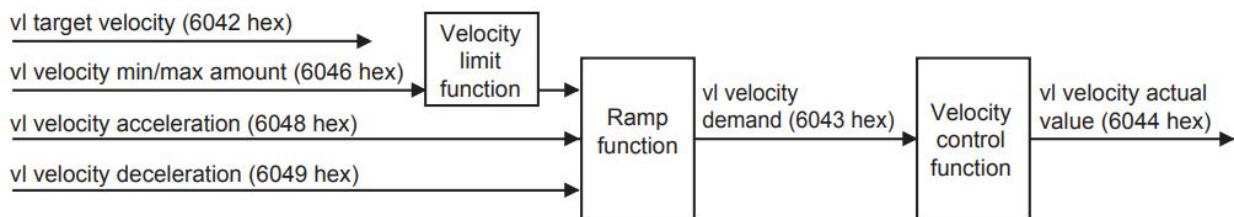

Object	Name	Description
6040 h	Controlword	Command to control the frequency converter
6041 h	Statusword	Returned status word corresponding to the instruction
6042 h	vl target velocity	Speed command to frequency converter (0.01%)
6046 h	vl velocity min/max amount	Minimum and maximum allowable output speeds
6048 h	vl velocity acceleration	Set acceleration time
6049 h	vl velocity deceleration	Set deceleration time
6043 h	vl velocity demand	Set speed command
6044 h	vl velocity actual value	Actual output speed(0.1Hz)

Note: 6043h and 6044h give the same value.

7.2.2 Torque mode

Object	Name	Description
6071 h	Target torque	Target torque
6077 h	Torque actual value	Torque actual value

8. Independent protocol object

The independent protocol object enables the master station to directly operate the VFD remotely, and all performance parameters directly use the parameters of the original frequency converter.

5000 hex	Command		
Range: 0000 ~ FFFF hex	Unit:-	Default value: 0000 hex	
Size: 2byte(U16)	Access: RW	PDO map: Possible	

This object directly provides action instructions to the VFD.

Bit description is as follows:

Bit	Meaning	Detail	
0	Forward	0:stop	1:Forward running
1	Reverse	0:stop	1:Reverse running
2-3	Reserved		
4	Parking mode	0:Deceleration shutdown	1: Free shutdown
5-6	Reserved		
7	Fault reset	1: Fault and warning clearing	
8	Enable effective	0: Default CiA402 protocol 1: Independent protocol (this agreement)	
9-15	Reserved		

- The instructions are as follows:

Forward running 0x0101 (decimal corresponding to 257)

Reverse running 0x0102 (decimal corresponding to 258)

Deceleration shutdown 0x0110 (decimal corresponding to 256)

Free shutdown 0x0100 (decimal corresponding to 272)

For example, 0x0101 is converted to binary 10000001, bit0 is 1, which means forward running, and bit8 is 1, which means independent protocol.

5010 hex	Target Speed		
Range: 0000 ~ FFFF hex	Unit: 0.01%	Default value: 0000 hex	
Size: 2byte(U16)	Access: RW	PDO map: Possible	

- The object gives the output frequency of the frequency converter.
- Refer to P0-13 and P0-14 for upper frequency limit and upper frequency source.

5100 hex	Status		
Range:0000 ~ FFFF hex	Unit : -	Default value: 0000 hex	
Size: 2byte(U16)	Access: RO	PDO map: Possible	

- The current state of the frequency converter.
- Bit description is as follows:

Bit	Meaning	Detail	
0	Operation / shutdown	0: Shutdown	1: Operation
1	Forward/Reverse	0: Forward	1: Reverse
2	Fault flag	0: Normal	1: Fault
3	Frequency arrival	1: Reach the set frequency	
4-6	Reserved	Normally 0	
7	Abnormal communication	0: normal	1: abnormal

8-15	Fault code	Refer to the VH5/VH6 frequency inverter manual or appendix
------	------------	--

5110 hex	Output Frequency		
Range: 0000 ~ FFFF hex	Unit : 0.1Hz	Default value: 0000 hex	
Size: 2byte(INT16)	Access: RO	PDO map: Possible	

5200 hex	Communicate State		
Sub-index 0: Number of entries			
Range: -	Unit : -	Default value: 0006hex	
Size: 1byte(U8)	Access: RO	PDO map: Not possible	
Sub-index 1: Number of frame lost			
Range:-	Unit : times	Default value: 0000hex	
Size: 2byte(U16)	Access: RO	PDO map: Not possible	
Sub-index 2: Number of CRC error CRC			
Range:-	Unit :times	Default value: 0000hex	
Size: 2byte(U16)	Access: RO	PDO map: Not possible	
Sub-index 3: Number of rejections			
Range:-	Unit :times	Default value: 0000hex	
Size:2byte(U16)	Access: RO	PDO map: Not possible	
Sub-index 4: Newest error cause			
Range: 0-3	Unit :-	Default value: 0000hex	
Size:2byte(U16)	Access: RO	PDO map: Not possible	
Sub-index 5: Newest error index			
Range: -	Unit :-	Default value: 0000hex	
Size:2byte(U16)	Access: RO	PDO map: Not possible	
Sub-index 6: Cycle time			
Range:-	Unit : ms	Default value: 0000hex	
Size:2byte(U16)	Access: RO	PDO map: Not possible	

- Sub-index 1~3 display the status of the communication data frame between the expansion card and the frequency converter.
- Sub-index 4 displays the latest error reason, 1/2/3 respectively represents sub objects 1 to 3, and 0 represents no error at present.
- Sub-index 5 displays the latest access object when an error occurs, which is used for fault location.
- Sub object 6 displays the cycle of the communication frame, which is generally 10ms (version below 3720) /15ms (version 3720). If the value is too large, it indicates that there is a problem in the communication with the frequency converter.
- This object is used to monitor and analyze the communication status between the expansion card and the frequency converter, which can be ignored in normal use.

Notes:

- ① The independent protocol does not support torque mode, only speed mode. If the customer wants to use torque mode, please use CiA402 protocol.
- ② The firmware version of VFD can be queried through P8-16.

9. CiA402 protocol object

603Fhex	Error code		
Range: 0000 ~ FFFF hex	Unit : -	Default value: 0000 hex	
Size:2byte(U16)	Access: RO	PDO map: Possible	

- This object displays the latest error or alarm code of the equipment.

Object	name	Data type	Description
603F hex	Error code	U16	0000: No error
			8**:EtherCAT expansion card related errors,please refer to 11. EtherCAT communication alarm code
			9**: error reported by frequency converter, ** is the error number of frequency converter For example, 901 indicates acceleration overcurrent,Err01 910 indicates motor overload,Err10 Refer to chapter 7-1 of <i>VH5/VH6 frequency inverter manual</i>

6040hex	Control word		
Range: 0000 ~ FFFF hex	Unit : -	Default value: 0000 hex	
Size:2byte(U16)	Access: RW	PDO map: Possible	

- This object controls the working state of the equipment.
- Bit description is as follows:

Bit	Name	Details
0	Switch on	The state is controlled by these bits. Quick stop is not supported.
1	Enable voltage	
2	Quick stop(reserved)	
3	Enable operation	
4-6	Reserved	Normally 0
7	Fault reset	Faults and warnings are cleared when this bit turns ON
8-15	Error code	Unused, normally 0

6041hex	Statusword		
Range :0000 ~ FFFF hex	Unit: -	Default value: 0000 hex	
Size:2byte(U16)	Access: RO	PDO map: Possible	

- This object displays the working status of the current equipment.
- Bit description is as follows:

Bit	Name	Details
0	Ready to switch on	these bits gives the state. Quick stop is not supported.
1	Switched on	
2	Operation enabled	
3	Fault	
4	Voltage enabled	
5	Quick stop	
6	Switch on disable	Normally 0
7	Warning	0:No warning occurred for the unit or inventor 1:Warning occurred for the unit or inventor
8	Reserved	Not used

9	Remote	0:Control from Controlword is disabled 1:Indicates that being performed by Controlword
10-15	Reserved	Not used

6042hex	vl target velocity		
Range :-32768-32767	Unit: 0.01%	Default value: 0	
Size: 2byte(INT16)	Access:RW	PDO map:Possible	

This object corresponds to the percentage of the maximum output frequency P0-13, namely:

$$vl \text{ target velocity} = \frac{\text{Data} \times \text{Maximum output frequency P0-13}}{10000}$$

Data corresponds to the value given in 6042h. The given range of data is 0~10000. Values beyond the given range cannot be written.

6043hex	vl velocity demand		
Range :-32768-32767	Unit: 0.01Hz	Default value: 0000 hex	
Size:2byte(INT16)	Access: RO	PDO map: Possible	

6044hex	vl velocity actual value		
Range :-32768-32767	Unit: 0.1Hz	Default value: 0000 hex	
Size:2byte(INT16)	Access: RO	PDO map: Possible	

- This object indicates the speed command fed back by the frequency converter.

6046hex	vl velocity min max amount		
Sub-index 0: Number of entries			
Range :-	Unit: -	Default value: 02hex	
Size:1byte(U8)	Access: RO	PDO map: Not possible	
Sub-index 1: vl velocity min amount (Lower limit frequency)			
Range :0 – FFFFFFFF hex	Unit: 0.01Hz	Default value: 00000000hex	
Size:4byte(U32)	Access: RW	PDO map: Not possible	
Sub-index 2: vl velocity max amount (Upper limit frequency)			
Range :0 – FFFFFFFF hex	Unit: 0.01Hz	Default value: 00001388hex	
Size:4byte(U32)	Access: RW	PDO map: Not possible	

- This object sets the maximum and minimum speed.
- Sub index 01 supports the minimum speed of reading and writing, which will be associated with frequency converter parameter P0-17
- Sub index 02 supports the maximum speed of reading and writing, which will be associated with frequency converter parameter P0-15(the maximum allowable setting value is determined by the maximum output frequency of P0-13)

6048hex	vl velocity acceleration		
Sub-index 0: Number of entries			
Range :-	Unit:-	Default value: 02hex	
Size:1 byte(U8)	Access: RO	PDO map: Not possible	
Sub-index 1: the maximum output frequency P0-13			
Range :0 – FFFFFFFF hex	Unit:0.01Hz	Default value: 00001388hex	
Size:4 byte(U32)	Access: RO	PDO map: Not possible	
Sub-index 2: Delta time			
Range :0 – FFFF hex	Unit:0. 1s	Default value: 00000200hex	
Size:2 byte(U16)	Access: RW	PDO map: Not possible	

- This object sets the acceleration time.
- Read / write delta time will be associated with VFD parameter P0-18.

6049hex	vl velocity deceleration		
Sub-index 0: Number of entries			
Range :-	Unit:-	Default value: 02hex	
Size:1 byte(U8)	Access: RO	PDO map: Not possible	
Sub-index 1: the maximum output frequency P0-13			
Range :0 – FFFFFFFF hex	Unit: 0.01Hz	Default value: 00001388hex	
Size:4 byte(U32)	Access: RO	PDO map: Not possible	
Sub-index 2: Delta time			
Range :0 – FFFF hex	Unit: 0.1s	Default value: 00000200hex	
Size:2 byte(U16)	Access: RW	PDO map: Not possible	

- This object sets the deceleration time.
- Read / write delta time will be associated with VFD parameter P0-18.

605Bhex	Shutdown option code		
Range :1	Unit:-	Default value: 1	
Size:2byte(INT16)	Access: RW	PDO map: Not possible	

- This object describes the action during shutdown (operation enable → ready to switch on). When this object is set to 1, it indicates deceleration shutdown, otherwise it will free shutdown.

605Chex	Disable operation option code		
Range :1	Unit:-	Default value: 1	
Size:2byte(INT16)	Access: RW	PDO map: Not possible	

- This object describes the action of canceling operation (operation enable → switch on). When this object is set to 1, it indicates deceleration shutdown, otherwise it will free shutdown.

605Ehex	Fault reaction option code		
Range :1	Unit:-	Default value: 1	
Size:2byte(INT16)	Access: RW	PDO map: Not possible	

- This object describes the action when an error occurs (operation enable → fault reaction active). When this object is set to 1, it means deceleration and shutdown, otherwise free shutdown (this function is reserved for standby).

6060hex	Mode of operation		
Range :2	Unit::-	Default value: 02 hex	
Size:1 byte(INT8)	Access: RW	PDO map: Not possible	

6061hex	Mode of operation display		
Range : 0 - 10	Unit:-	Default value: 02 hex	
Size:1 byte(INT8)	Access: RO	PDO map: Not possible	

- This object displays the current operation mode, which is equal to 6060 hex (mode of operation) during operation.

6064hex	Position actual value		
Range :-2147483648 - 2147483647	Unit:-	Default value: 00000002 hex	
Size:4 byte(U32)	Access: RO	PDO map: Not possible	

- This object displays the encoder position fed back by the frequency converter.

6071hex	Target torque		
Range :-32768 -32767	Unit: 0.01%	Default value: 0	
Size:2 byte(INT16)	Access: RW	PDO map: Possible	

6077hex	Torque actual value		
Range :-32768 -32767	Unit:0.01%	Default value: 0	
Size:2 byte(INT16)	Access: RO	PDO map: Possible	

- This object displays the torque command fed back by the frequency converter.

6502hex	Supported drive modes		
Range : 0 - 10	Unit:-	Default value: 00000002 hex	
Size:4 byte(U32)	Access: RO	PDO map: Not possible	

- This object displays the operation mode supported by expansion card.
- Bit description is as follows:

Bit	Supported mode	Definition
0	pp (Profile Position mode)	0:Not supported
1	vl (velocity mode)	1:Support
2	pv (Profile Velocity mode)	0:Not supported
3	tq (Profile Torque mode)	0:Not supported
4	Reserved	0
5	hm (Homing mode)	0:Not supported
6	ip (Interpolated Position mode)	0:Not supported
7	esp (Cyclic Sync Position mode)	0:Not supported
8	csv (Cyclic Sync Velocity mode)	0:Not supported
9	cst (Cyclic Sync Torque mode)	1:support
10 - 31	Reserved	0

10. EtherCAT use case

10.1 XINJE XDH series PLC and VH5/VH6

10.1.1 System topology

VH5/VH6 has two communication network ports. The network port at the upper end is the outgoing port (out port) and the network port at the lower end is the incoming port (in port). The principle of "bottom in and top out" shall be followed when connecting multiple frequency converters.

VH5 and VH6 EtherCAT expansion cards are connected to PLC master station and frequency converter slave station according to the series topology shown in the figure below.

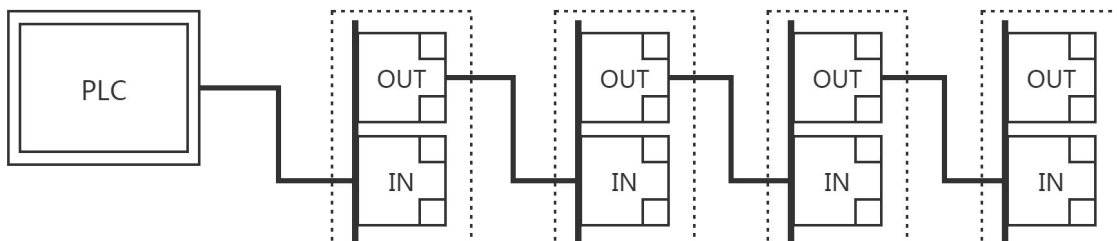

10.1.2 Physical wiring

Take Xinje XDH series PLC and VH5 as an example, the physical wiring is shown in the figure:

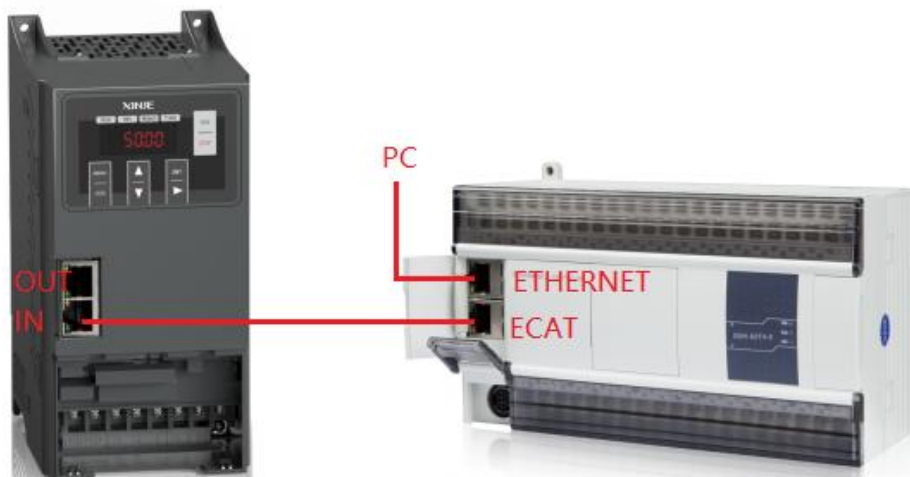

10.1.3 System configuration

10.1.3.1 Parameter setting

The frequency converter slave station needs to be configured as EtherCAT communication mode, and the parameters to be modified are as follows:

Parameter	Name	Access	Set value	Range	Explanation
P0-02	Operation command channel selection	Runtime read only	2	0-2	Communication
P0-03	Main frequency A input channel	Runtime read	6	0-9	Communication setting

	selection	only			
P9-00	Communication protocol	Runtime read only	1	0-2	EtherCAT
P9-12	Slave station No.	RW	-	0-65535	After modification, it is valid when power on again.

Note: When using the CiA402 protocol for control, other parameters of the frequency converter can be factory parameters. **If the master station supports automatic reading of the slave station number (e.g. Xinje bus type PLC), P9-12 does not need to be set.**

10.1.3.2 Add XML file

Before opening the PLC software, you need to add the XML file. (when installing the XDPPro software, the XML file of frequency conversion has been included.) If you need to update the XML file, please go to the official website → service and support → download center to download it by yourself.

Right click XDPPro software, open the location of the file, find the directory **【plugins\ethercat\vendorxml】**, and add the XML file here.

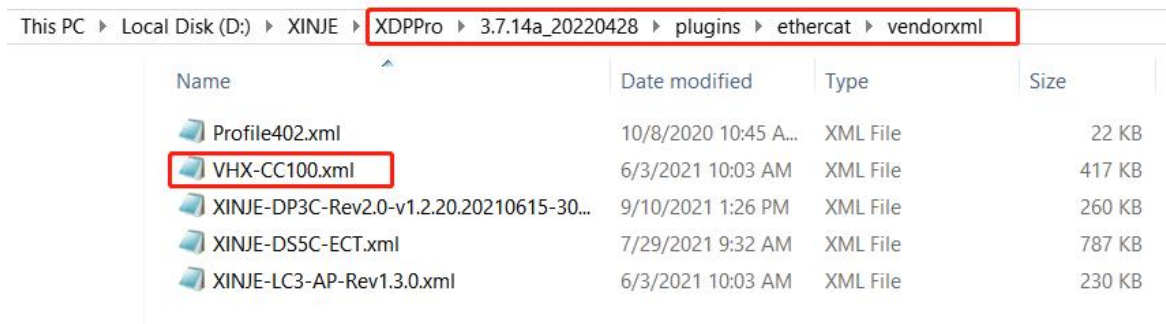

10.1.3.3 New project(take XDH-60T4 as an example)

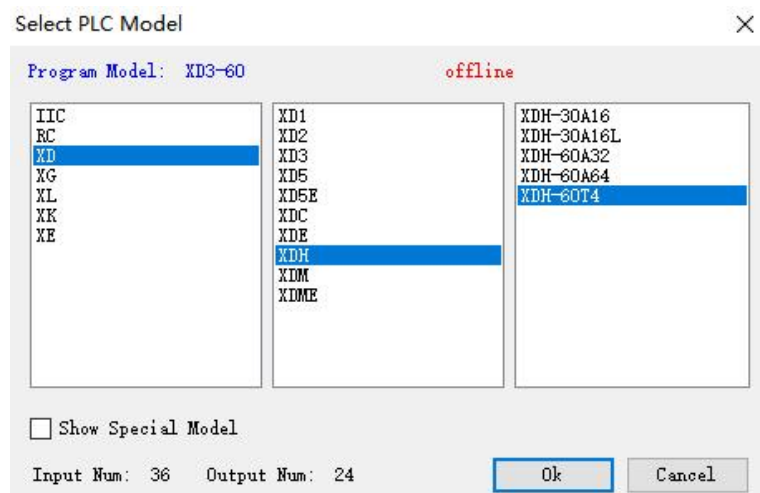

10.1.3.4 Master connection configuration

1.Computer configuration

After the network cable is plugged in, open "control panel" → "network and Internet" → "network connection".

Find the Ethernet that has been successfully connected. Right click the Ethernet and click properties. The Ethernet properties interface pops up. Then follow the steps below:

- (1) Double click "Internet Protocol Version 4 (TCP/IPv4)".
- (2) Select "use the following IP address".
- (3) Set IP address: 192.168.6.xxx, "xxx" can be set arbitrarily (except 6).

Note: The last digit of the computer address and the IP address of the PLC device cannot be set repeatedly.

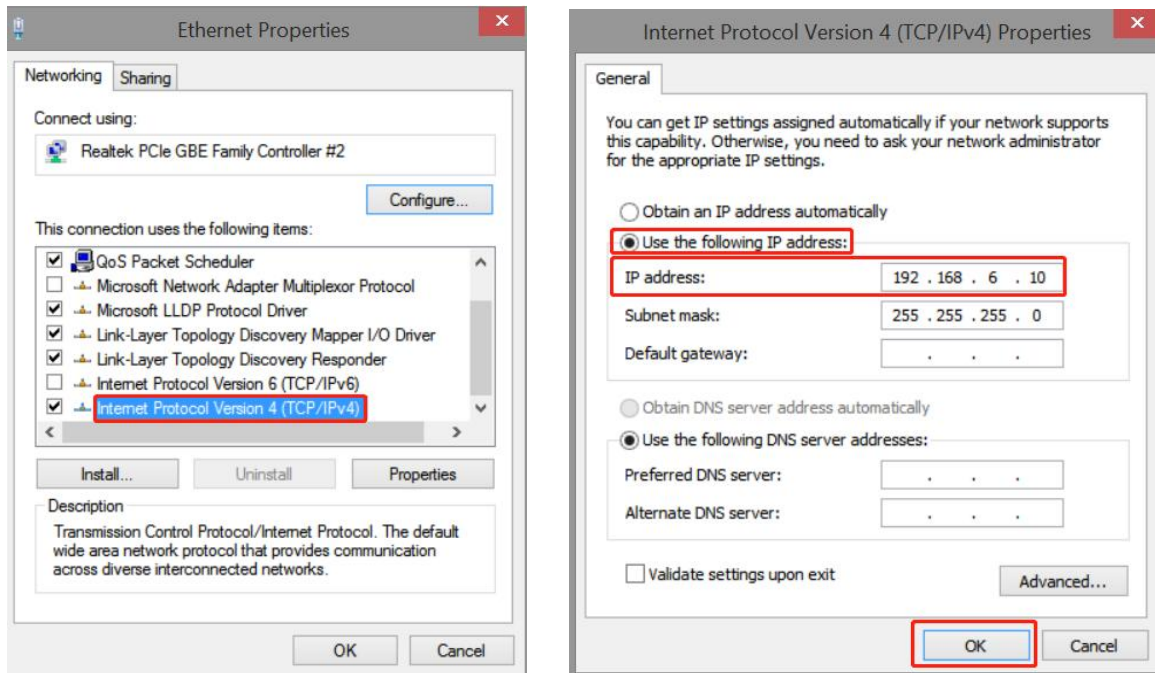

2. PLC configuration

After checking the wiring and Ethernet configuration, open XDPPRO programming tool → click communication configuration → double click Ethernet-Xnet.

Configure according to the following figure:

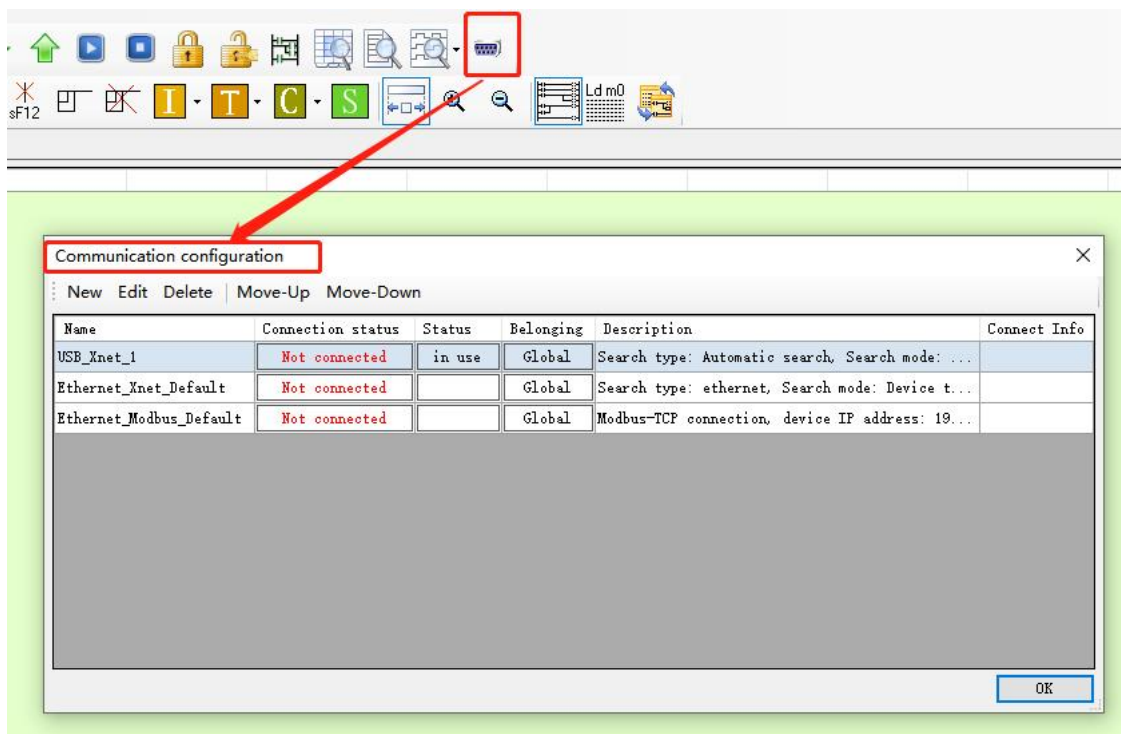

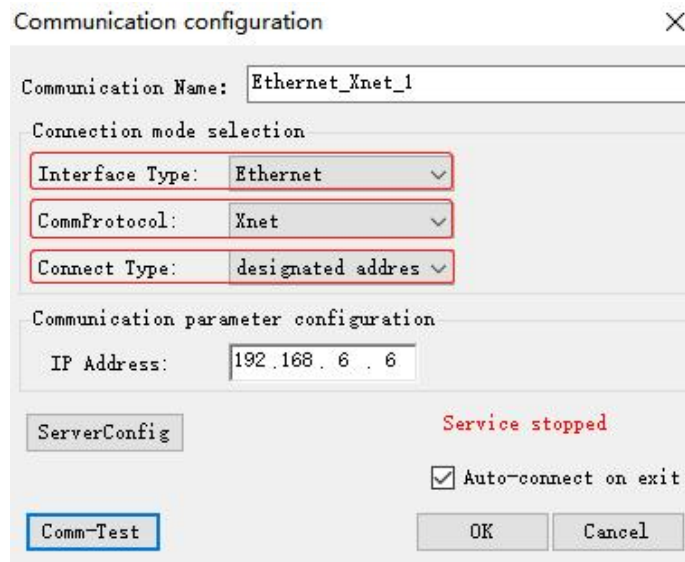

Click OK after configuration and select " in use" for corresponding status.

After the communication connection is successful, find the "PLC configuration" column, click "EtherCAT" to open the configuration interface, click "Scan", and then the page will display the scanned slave station and master station.

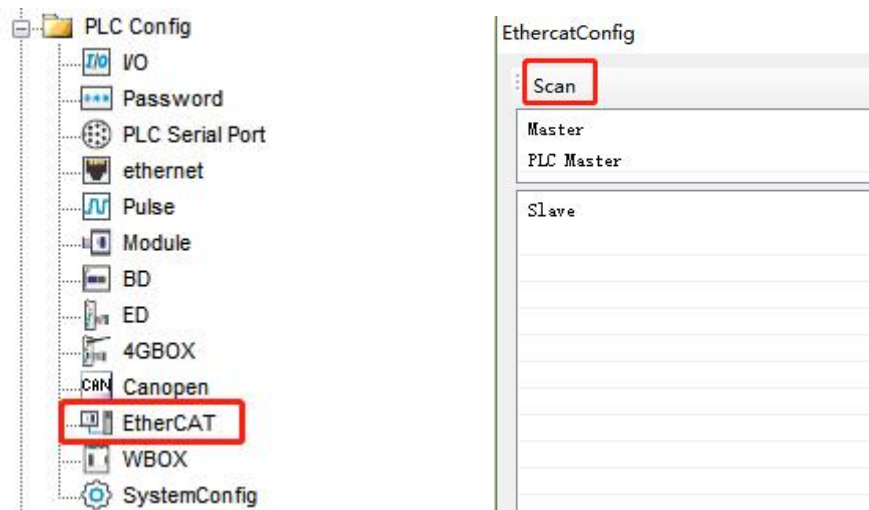

10.1.4 Control under CIA 402 protocol and Independent protocol

10.1.4.1 Configuration

- (1) Click Scan
- (2) Select the function module: User Define/Servo Module
- (3) Click write, then click activate
- (4) Confirm that the State Machine is switched to the OP state.
- (5) Enter the Expert process data and click input and output respectively.

PDO allocation selection 1600 (CiA402 protocol).

PDO allocation selection 1601 (Independent protocol).

The PDO list can be selected. If you need to set a new address, you can add or modify it in the PDO content.

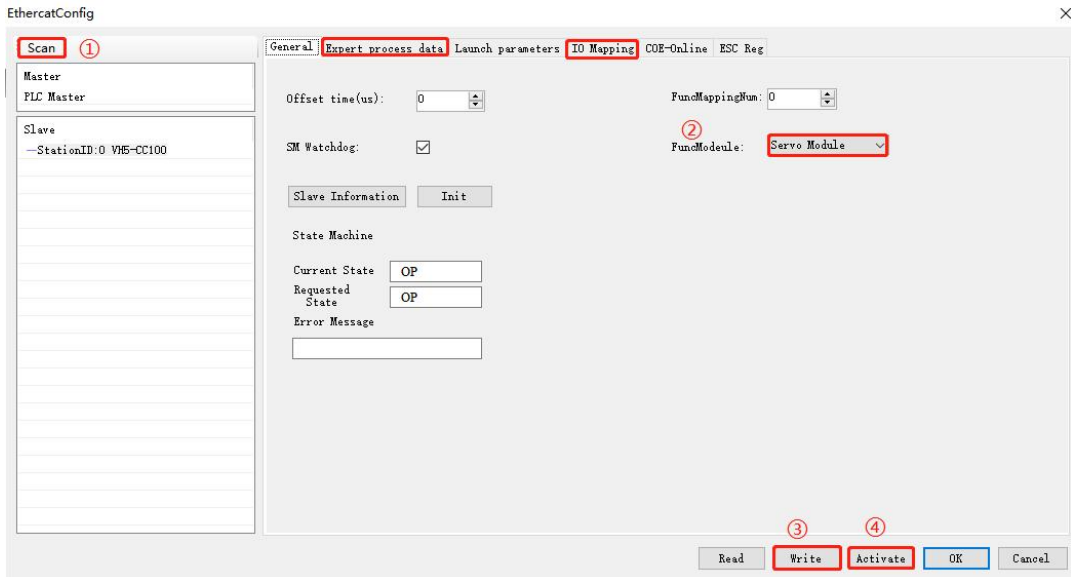

Note: If you need to use the function module: **Servo Module**, please ensure that the PLC firmware is 3.7.2 and above, and update the PLC programming software to version 3.7.14b or above. Use A_ PWR instruction to control the start and stop of frequency conversion.

10.1.4.2 CiA402 protocol control

1) Enter the Expert process data and click “Input” and “Output” respectively in the SynManager. Select 1600, 1a00 from PDO list. If you need a new address, you can add or modify it in the PDO content. After checking, click configuration write and activate.

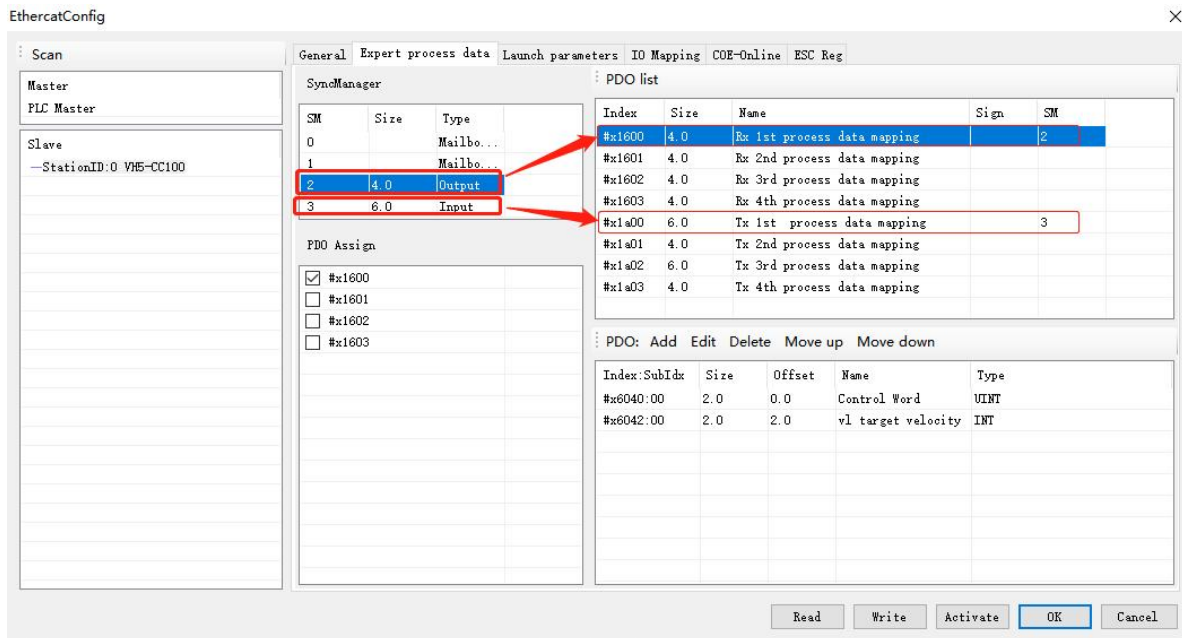

2) View the register address of the control word through IO mapping

Note: the specific IO address value shall be used according to the actual display setting of PLC

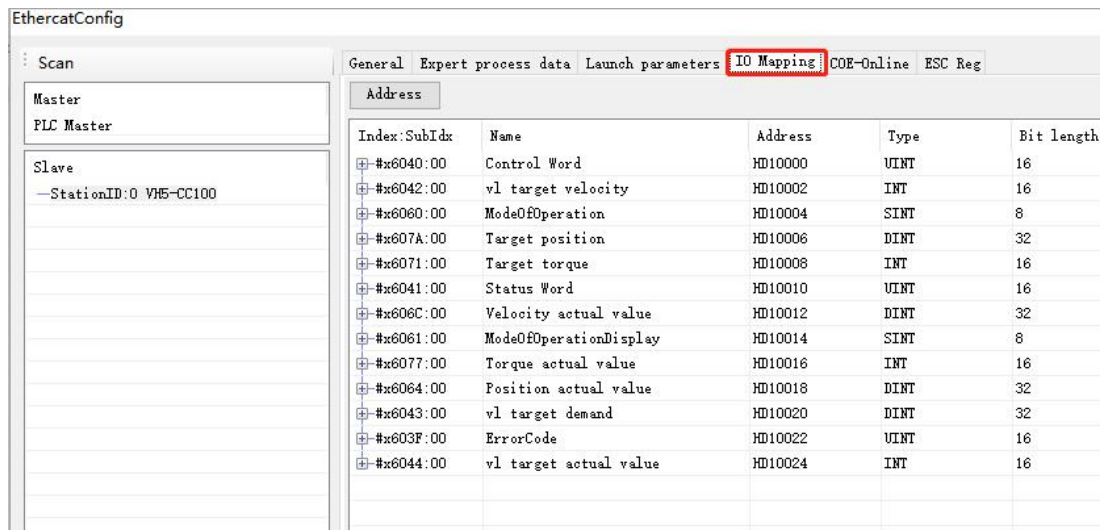

3)VFD operation (function module selection: User define & speed mode: PF-00=0 as an example)



Set **【6060h: Mode of operations】** to 2 (speed mode).

Set **【6040h: Control word】** to start / stop the frequency converter.

For example, when 15 is written, the VFD starts. Write the value other than 15, and the VFD stops. Write 128 to clear the VFD alarm.

Set **【6042h:vl target velocity】**, which corresponds to the percentage of the maximum output frequency P0-13

$$vl \text{ target velocity} = \frac{\text{Data} \times \text{Maximum output frequency P0-13}}{10000}$$

Data corresponds to the value given in 6042h. The given range of data is 0~10000. Values beyond the given range cannot be written.

For example: P0-13=50.00Hz, if 1000 is written in 6042h, the frequency converter operates at 5.00Hz forward, write -1000, and the frequency converter operates at 5.00Hz reverse.

Set **【6071h: target torque】** to set the upper limit value of torque in the speed mode, which is 150.0% by default.

Read **【6041h: status word】** to obtain the status feedback of the frequency converter.

Read **【6064h: position actual value】** to obtain encoder position feedback. (only valid when PG card is used).

Read **【603Fh: ErrorCode】** to obtain the alarm code. For details, refer to Chapter 11. Alarms related to EtherCAT communication.

Note:

① Check the version number of the expansion card through the frequency converter U4-09. If U4-09=100, 6042h will give the frequency (unit: 0.01Hz).

For example, if 1000 is written in 6042h, the frequency converter operates in forward direction at 10.00 Hz, if -1000 is written, the frequency converter operates in reverse direction at 10.00 Hz.

②Parameters in torque mode

Parameter	Name	Access	Set value	Range	Explanation
PF-00	Torque control	Runtime read only	1	0: Speed control 1: Torque control	Torque control
PF-01	Upper limit source of driver torque	Runtime read only	5	0-7	communication setting
PF-03	Torque control forward maximum frequency source	Can be modified during operation	5	0-7	communication setting
PF-05	Torque control inverse maximum frequency source	Can be modified during operation	5	0-7	communication setting

Set **【6071h: target torque】** to set the torque setting.

When the torque is given as positive, the VFD operates in the forward direction.

When the torque is given as negative, the VFD operates in the reverse direction.

For example, if 1000 is set, the frequency converter operates at 10.00% of the rated torque

Set **【6042h:vl target velocity】** to modify the upper speed limit (0.01%) under torque mode, corresponding to the percentage of maximum output frequency P0-13.

10.1.4.3 Independent protocol control

(1) Enter the expert process data and click input and output respectively in the synchronization manager. PDO allocation selection 1601,1a01. If you need to set a new address, you can add or modify it in the PDO content. After checking, click write and activate.

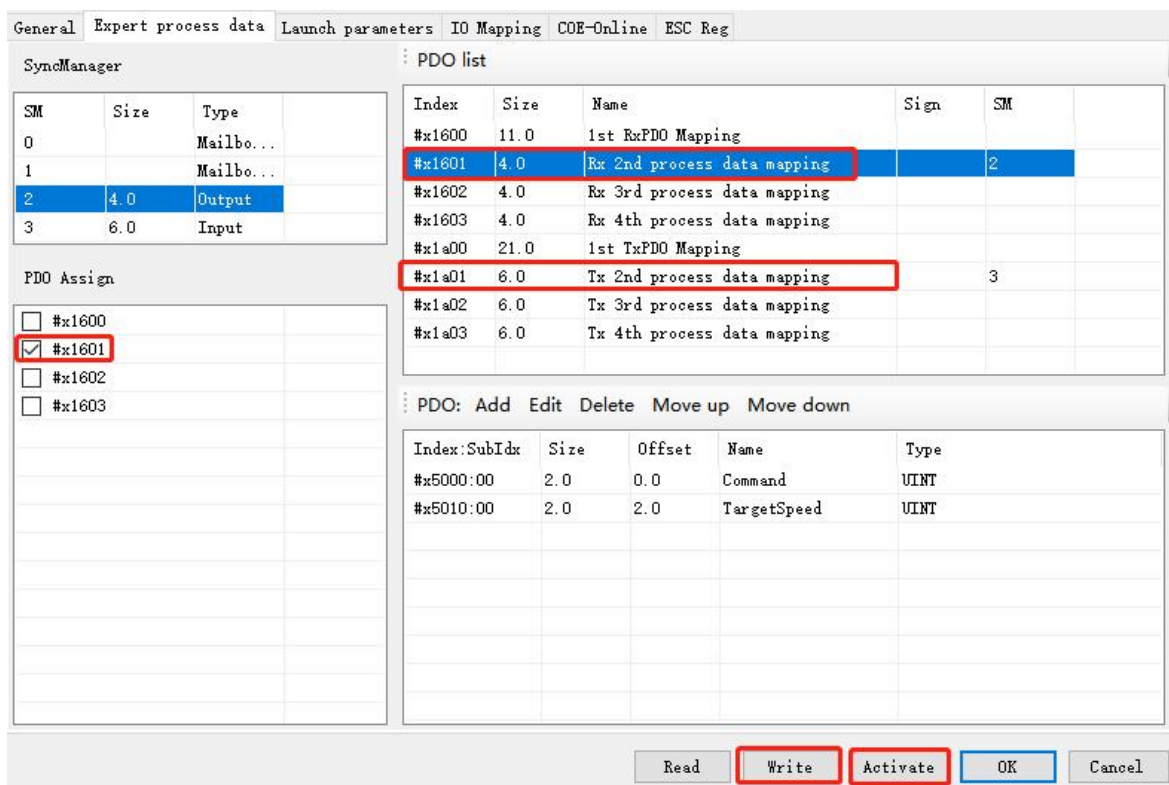

(2) View the register address of the control word through IO mapping

Note: the specific IO address value shall be used according to the actual display setting of PLC.

General		Expert process data		Launch parameters		IO Mapping		COE-Online		ESC Reg	
Address											
Index:SubIdx	Name	Address	Type	Bit length							
+ #x5000:00	Command	HD10026	UINT	16							
+ #x5010:00	TargetSpeed	HD10028	UINT	16							
+ #x5100:00	Status	HD10030	UINT	16							
+ #x5110:00	OutputFrequency	HD10032	DINT	32							

(3) VFD Operation

Set **【6060h:Mode of operations】** to 2 (speed mode)

Set **【5000h:Command】** to control the frequency converter.

For example, if 257 is written, the frequency converter will run forward. Write 256, and the frequency converter deceleration shutdown. Other commands can be converted by customers. (see Chapter 8 for detailed usage rules)

Set **【5010h:Target Speed】**, which corresponds to the percentage of the maximum output frequency P0-13

$$v1 \text{ target velocity} = \frac{\text{Data} \times \text{Maximum output frequency P0-13}}{10000}$$

Data corresponds to the value given in 5010h. The given range of data is 0~10000. Values beyond the given range cannot be written.

For example: P0-13=50.00Hz, if 1000 is written in 5010h, the frequency converter operates at 5.00Hz forward, write -1000, and the frequency converter operates at 5.00Hz reverse.

Read **【5100h: status word】** to obtain the status feedback of the frequency converter.

10.1.5 Instruction read / write

Note: Select the corresponding register address according to different protocols.

Taking the CiA402 protocol as an example:

(1) Write SDO write instructions to associate addresses with registers, or modify parameters with corresponding register addresses.

Example ①: Modify the acceleration time P0-18 through SDO write instruction. According to chapter 6.3, write the object index of reading acceleration time P0-18: H2012.

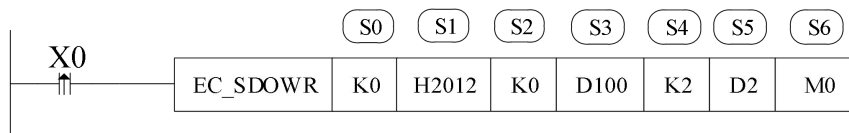

Operand	Function	Range	Type
S0	EtherCAT slave station no.: Station ID	0~63	16-bit constant or single word register
S1	Object index	0x1000~0xffff	16-bit constant or single word register
S2	Object subIndex	0~255	16-bit constant or single word register
S3	Write value register		single word register
S4	write value byte length		16-bit constant or single word register
S5	Status register		single word register
S6	Completion flag bit		Bit

Example ②: Read the deceleration time P0-19 through SDO reading instruction. According to chapter 6.3, write the object index of deceleration time P0-19: H2013.

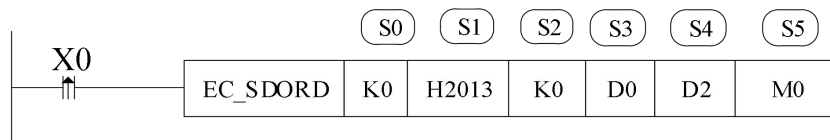

Operand	Function	Range	Type
S0	EtherCAT slave station no.: Station ID	0~63	16-bit constant or single word register
S1	Object index	0x1000~0xffff	16-bit constant or single word register
S2	Object subIndex	0~255	16-bit constant or single word register
S3	Value register		Single word register
S4	Status register		Single word register
S5	Completion flag bit		Bit

Note: ①The first slave station ID is 0, not 1.

②For instructions, please refer to *XDHLH motion control manual*.

10.2 Omron series PLC and VH5/VH6(CiA402 protocol)

10.2.1 System configuration

Name	Model	Quantity	Explanation
Upper computer	Sysmac Studio	1	Omron upper computer software
Controller	OMRON NJ501-1500 series	1	-
Communication card	VHX-CC100(V2.0)	1	-
Network cable	JC-CB-3	some	For connection between computer and PLC and between PLC and VFD

10.2.2 Parameter setting

The frequency converter slave station needs to be configured as EtherCAT communication mode, and the parameters to be modified are as follows:

Parameter	Name	Access	Set value	Range	Explanation
P0-02	Operation command channel selection	Runtime read only	2	0-2	Communication
P0-03	Main frequency A input channel selection	Runtime read only	6	0-9	Communication setting
P9-00	Communication protocol	Runtime read only	1	0-2	EtherCAT
P9-12	Slave station No.	RW	-	0-65535	After modification, it is valid when power on again.

10.2.3 Setup steps

1) New project

Open the Omron upper computer software SYSMAC studio. If "new project" is selected for the first time, select the model: NJ501-1500, version 1.02 in the project attribute interface, and click "create" to generate the programming interface.

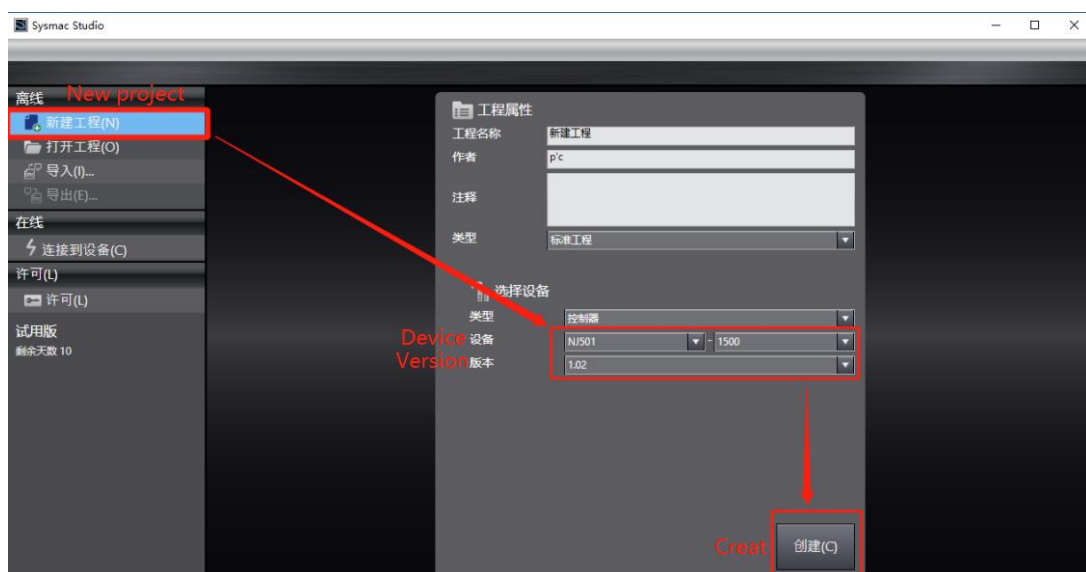

2) Add XML file

For initial use, customers need to add XML files to the library. Double click “EtherCAT”, pop up the EtherCAT configuration screen. Right click master device and select “Display ESI Library”.

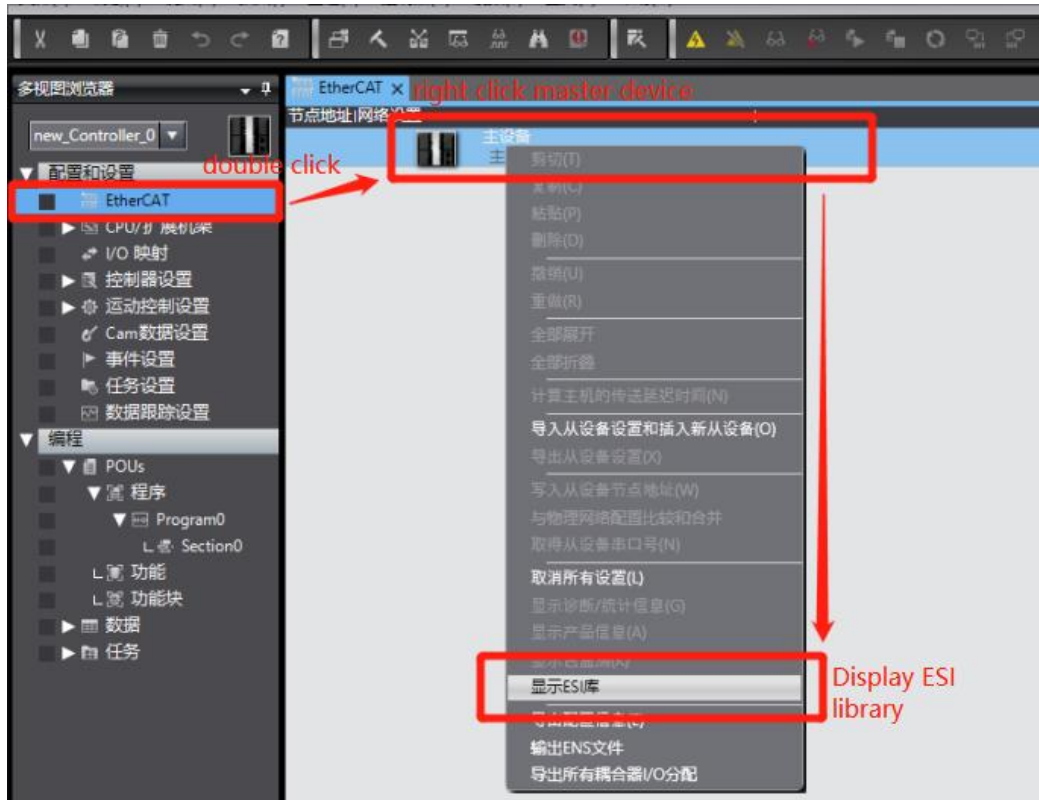

Then in the pop-up ESI library, we need to add the XML file of VHX-CC100. Select “this folder” to display the path of the storage folder, where the “VHX-CC100” XML type file is placed.

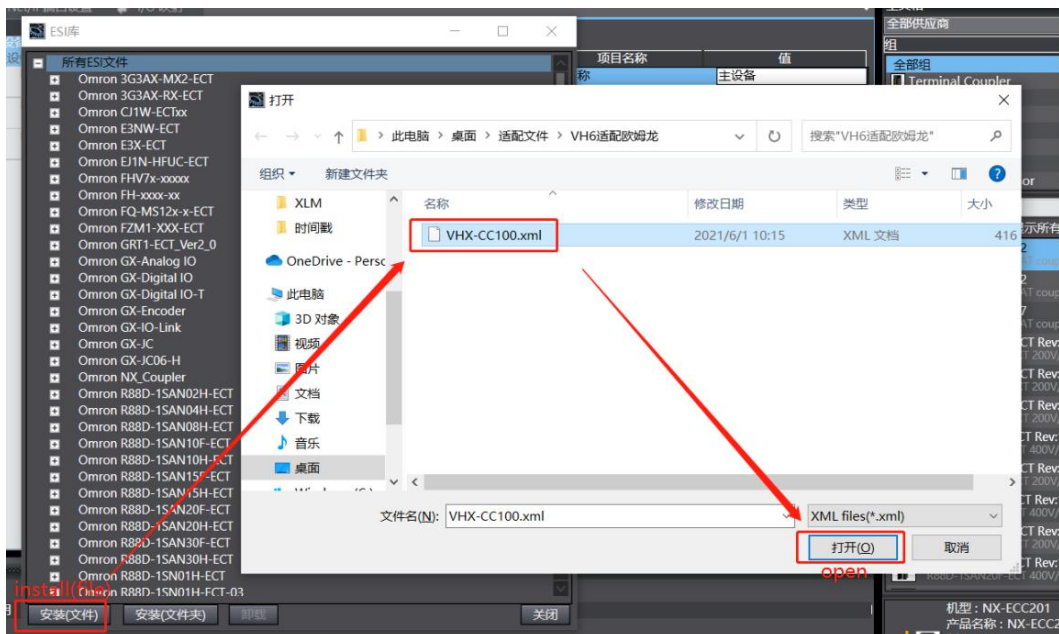

The installation is completed as shown below:

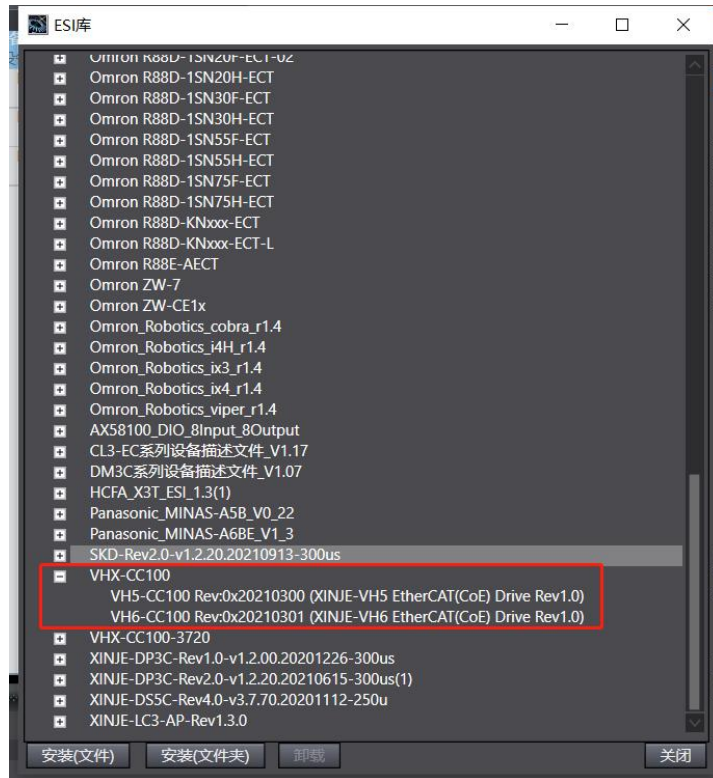

3) Scan and add devices

When using the device, ensure that P9-12 is set. The station number can be increased from 1 in actual connection sequence. After modification, it needs to be powered on again.

If the controller is online, right-click the master device to compare and merge the configurations with those of the physical network.



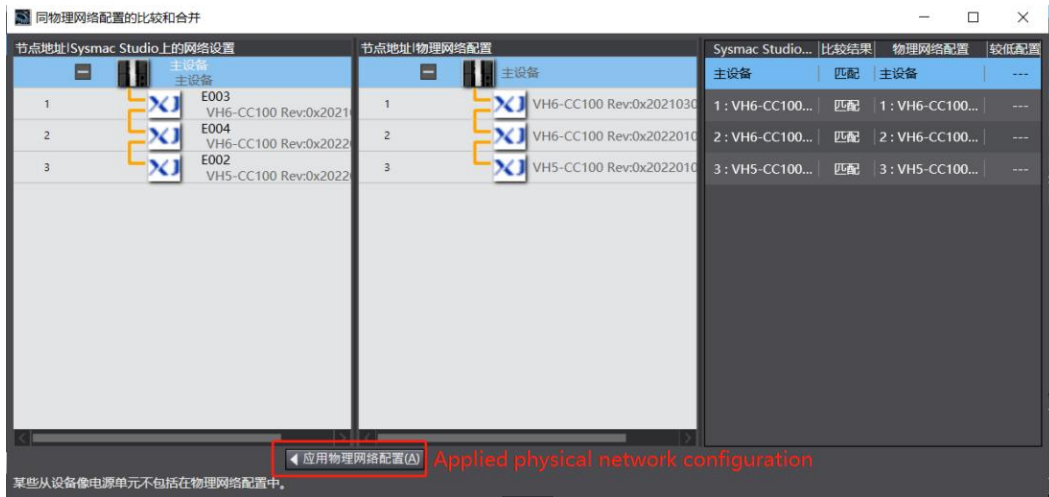

The actual connection is shown in the following figure:

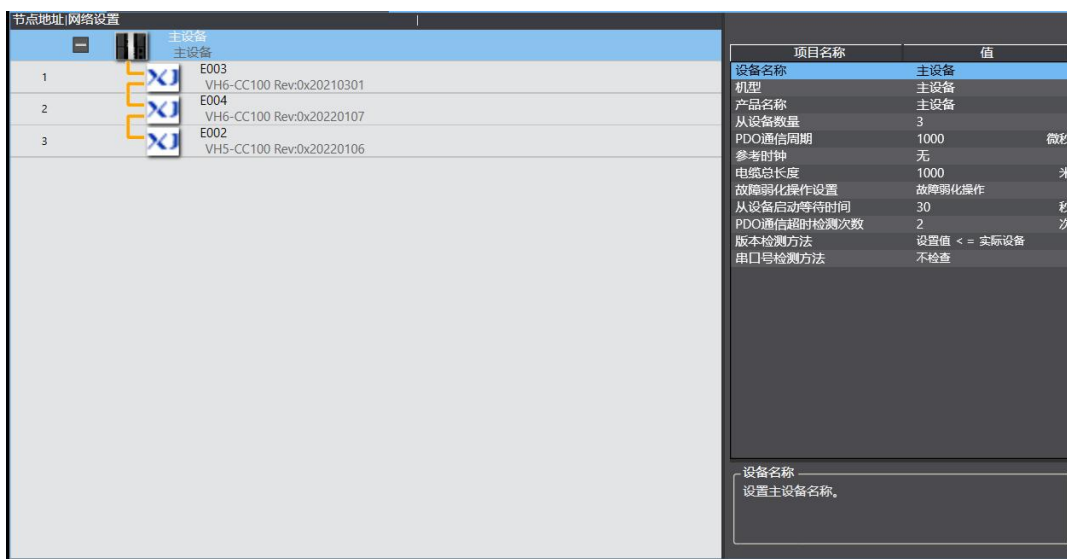

4) Add Group U parameters to the PDO.

After adding a node, select the node with the cursor to display the current node PDO configuration. Select “Edit PDO mapping settings”. The pop-up interface displays the current output PDO mapping on the left and PDO entries on the right. You can add or delete PDO as required.

To add a PDO, select “Add PDO entry”, and the PDO object that can be added will be displayed in the pop-up window. Select it, click OK, and then click apply to add it successfully.

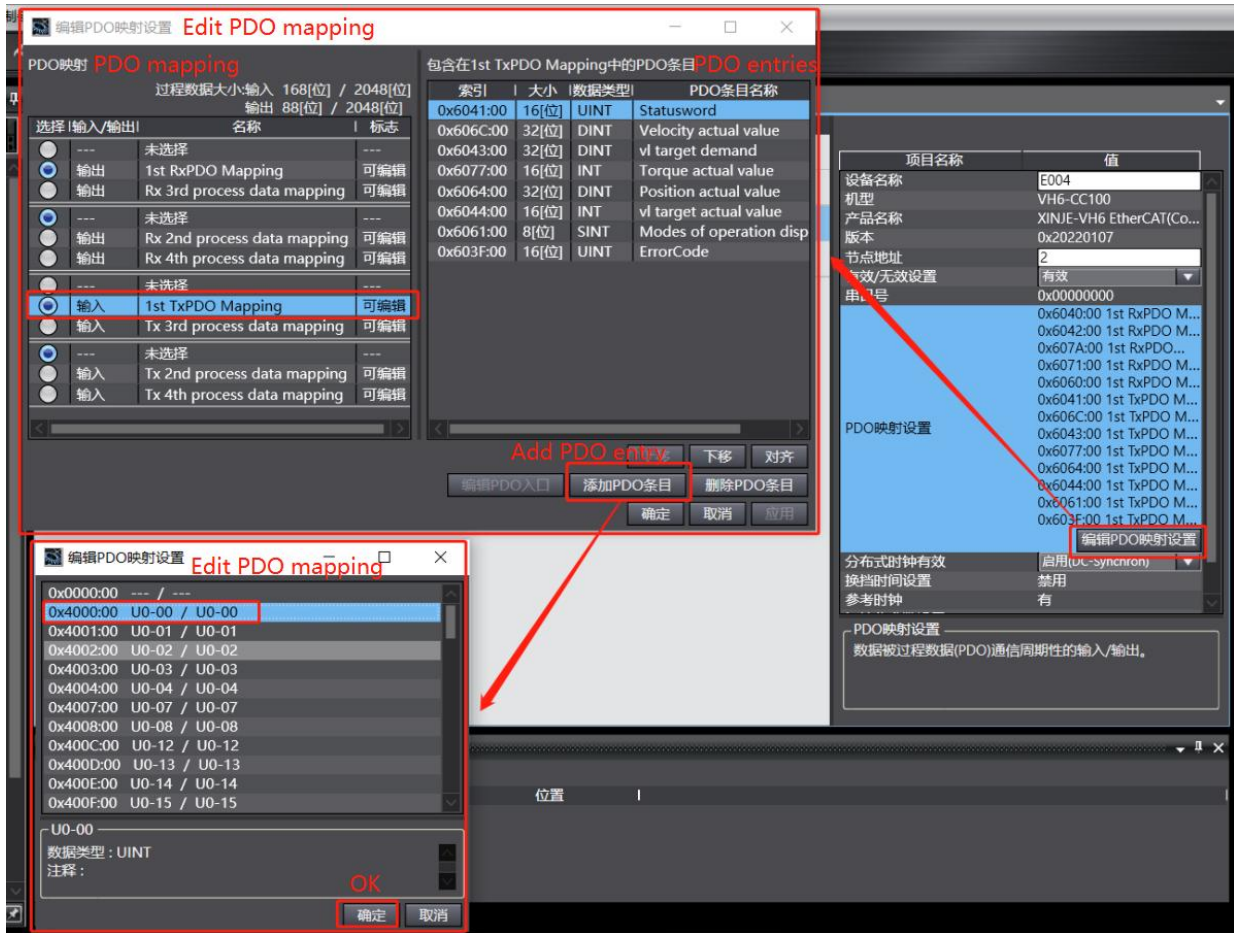

After adding, see the following figure:

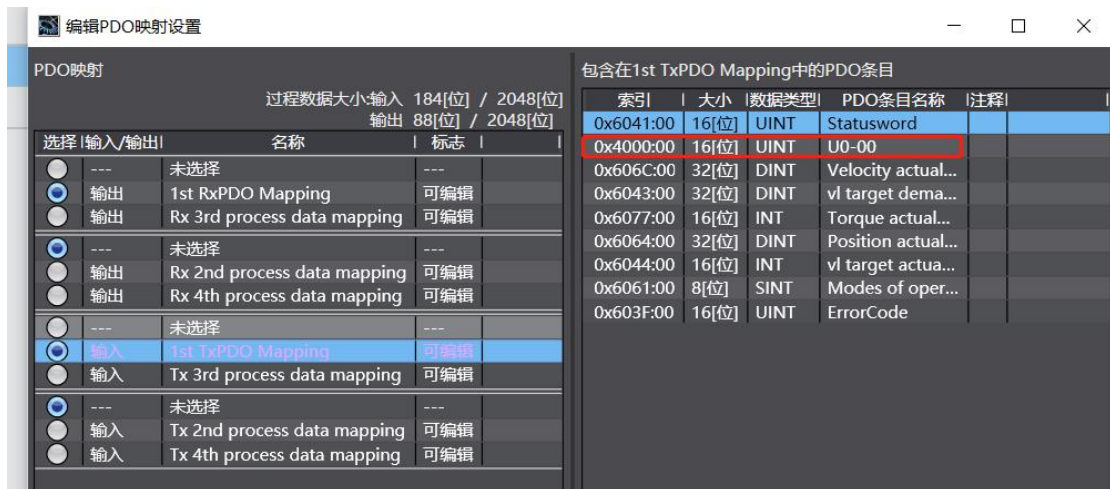

5) Gateway communication settings

First, check the IP address of the PLC: in the multi view browser, select Controller settings→Bulit-in Ethernet/IP

port settings→ TCP/IP settings.

In the configuration interface, you can view the fixed IP address set by the current project. For a new program, the default IP address is 192.168.250.1.



Select Controller - Communicate setting



Select "Ethernet - Direct connection" in the "communication setting" interface, and then click "OK" to close the interface.

Note: Ethernet connection requires that the IP address of the connected device (PC) is automatically obtained or within the PLC IP address network segment, so confirm whether the IP address setting of the PC meets the requirements before connection.

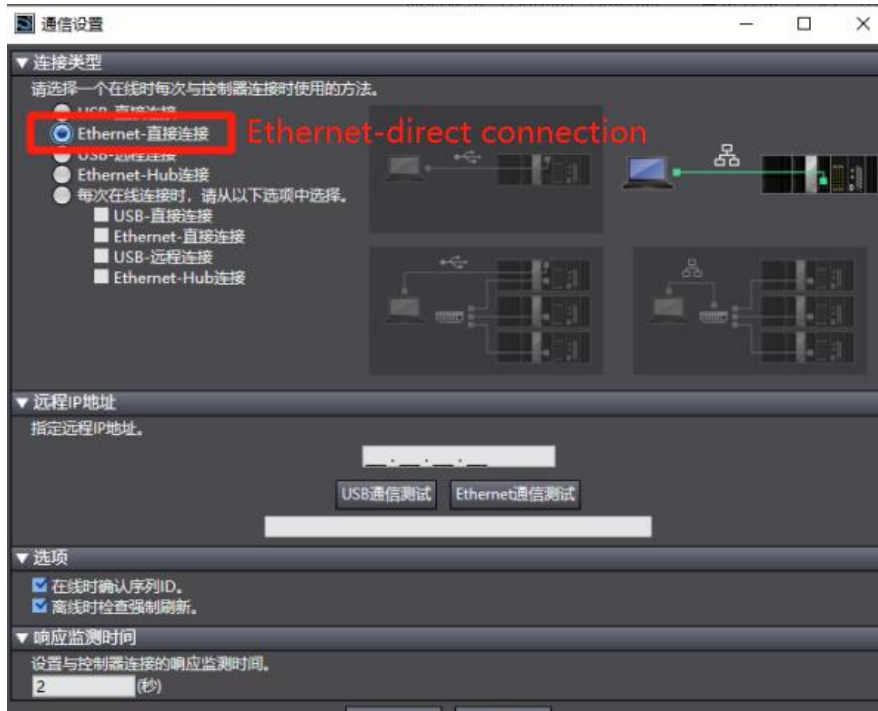

6) Synchronous Download

Select synchronize in the toolbar, and a pop-up window will pop up to compare the local project with the project in the controller. The local project is different from the project in the controller and “out of sync” is displayed . If you click transfer to controller, the local project will be downloaded and the original project of the controller will be overwritten.

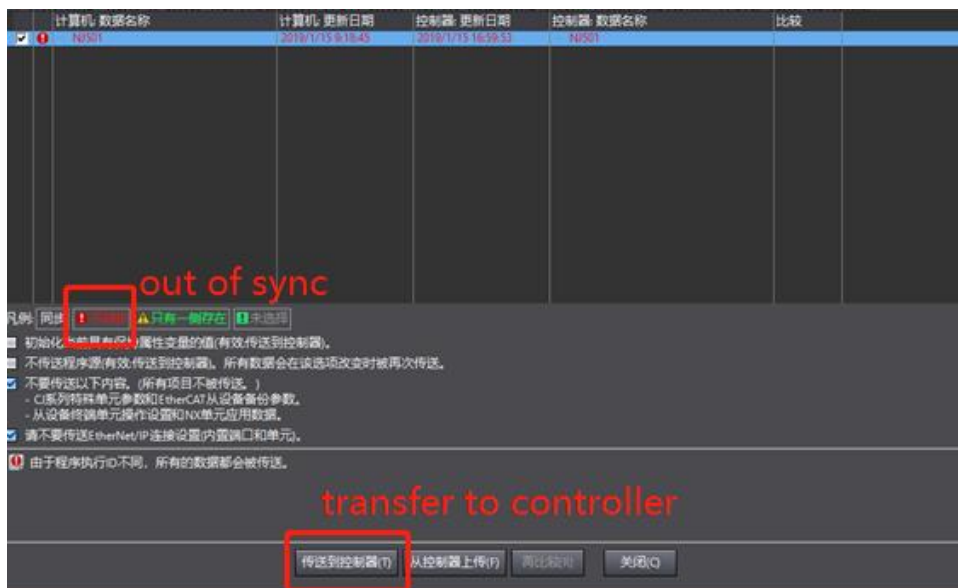



After synchronization is completed, click recomparsion to view the synchronization of the entries of the local project and the controller project. When the subsequent modified projects are synchronized again, the entries different from the controller project will be marked in detail.

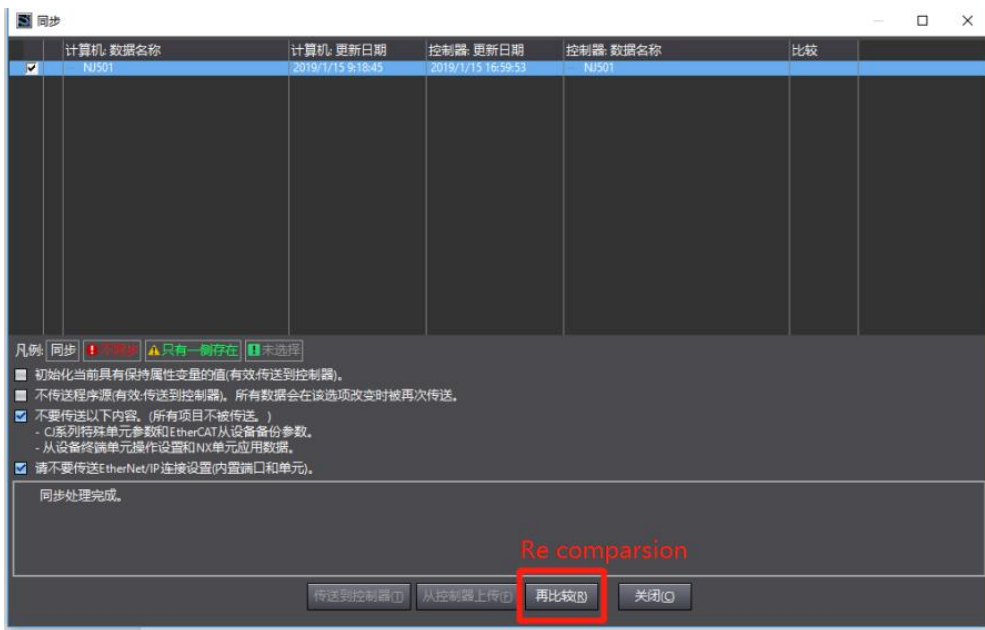

7)PDO data read/write(enable and speed setting)

PDO object data can monitor real-time changing values through "IO mapping".



位置	端口	说明	R/W	数据类型	值	变量	变量注释
节点1	EtherCAT网络配置						
	VHS-CC100						
		Rx 1st process data mapping_Controlword_6040_00	W	UINT	0		
		Rx 1st process data mapping_vl target velocity_6042_00	W	INT	0		
		Tx 1st process data mapping_Statusword_6041_00	R	UINT	4688		
		Tx 1st process data mapping_vl target demand_6043_00	R	INT	0		
		Tx 1st process data mapping_vl target actual value_6044_00	R	INT	0		
节点2	VHS-CC100						
节点3	VHS-CC100						
		1st RxPDO Mapping_Controlword_6040_00	W	UINT	0		
		1st RxPDO Mapping_vl target velocity_6042_00	W	INT	0		
		1st RxPDO Mapping_Modes of operation_6060_00	W	SINT	0		
		1st RxPDO Mapping_Target position_607A_00	W	DINT	0		
		1st RxPDO Mapping_Target torque_6071_00	W	INT	0		
		1st TxPDO Mapping_Statusword_6041_00	R	UINT	4688		
		1st TxPDO Mapping_Velocity actual value_606C_00	R	DINT	0		
		1st TxPDO Mapping_Modes of operation display_6061_00	R	SINT	2		
		1st TxPDO Mapping_Torque actual value_6077_00	R	INT	0		
		1st TxPDO Mapping_Position actual value_6064_00	R	DINT	0		
		1st TxPDO Mapping_vl target demand_6043_00	R	DINT	0		
		1st TxPDO Mapping_ErrorCode_603F_00	R	UINT	0		
		1st TxPDO Mapping_vl target actual value_6044_00	R	INT	0		
	CPU扩展机架						
CPU机架0	CPU机架0						

Set **【6040h: Control word】** : write 6 → 7 → 15 enable. 15 → 7 turn off enable. Write 128 to clear the frequency conversion alarm.

Set **【6042h:vl target velocity】**, for example, write 1000, P0-13=50Hz. The frequency converter operates with 5Hz forward rotation, writes -1000, and the frequency converter operates with 5Hz reverse rotation.

8)SDO data read/write

Variable definition and assignment:

命名空间 - 使用							
内部/外部	名称	数据类型	初始值	分配到	保持	常量	注释
外部	Trigger	BOOL	False		<input type="checkbox"/>	<input type="checkbox"/>	1
	SdoObject	_sSDO_ACCESS	(Index := 0, Subindex := 0)		<input type="checkbox"/>	<input type="checkbox"/>	
	EC_CoESDORead_instance	EC_CoESDORead			<input type="checkbox"/>	<input type="checkbox"/>	
	VersionInfo	UINT	0		<input type="checkbox"/>	<input type="checkbox"/>	
	DoSdoRead	BOOL	False		<input type="checkbox"/>	<input type="checkbox"/>	
	ErrorEnd	UINT	0		<input type="checkbox"/>	<input type="checkbox"/>	
	ADDHGD	BOOL	False		<input type="checkbox"/>	<input type="checkbox"/>	
	NormalEnd	UINT	0		<input type="checkbox"/>	<input type="checkbox"/>	
	ASD	BOOL	False		<input type="checkbox"/>	<input type="checkbox"/>	
	asdf	DWORD			<input type="checkbox"/>	<input type="checkbox"/>	
	sdfy	UINT			<input type="checkbox"/>	<input type="checkbox"/>	
	EC_CoESDOWrite_instance	EC_CoESDOWrite			<input type="checkbox"/>	<input type="checkbox"/>	
	Trigger1	BOOL			<input type="checkbox"/>	<input type="checkbox"/>	
	ASD1	BOOL			<input type="checkbox"/>	<input type="checkbox"/>	
	ADDHGD1	BOOL			<input type="checkbox"/>	<input type="checkbox"/>	
	asdf1	DWORD			<input type="checkbox"/>	<input type="checkbox"/>	
	VersionInfo1	UINT			<input type="checkbox"/>	<input type="checkbox"/>	
	SdoObject1	_sSDO_ACCESS	(Index := 0, Subindex := 0)		<input type="checkbox"/>	<input type="checkbox"/>	

Programming:

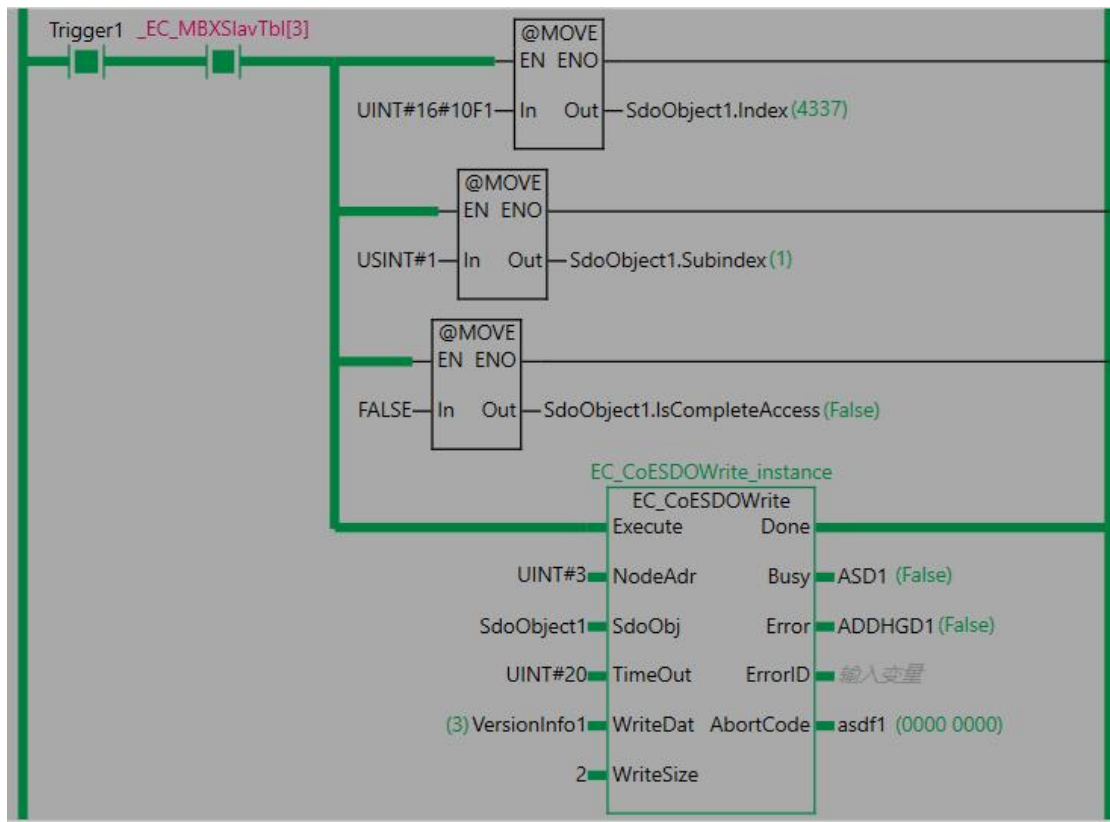
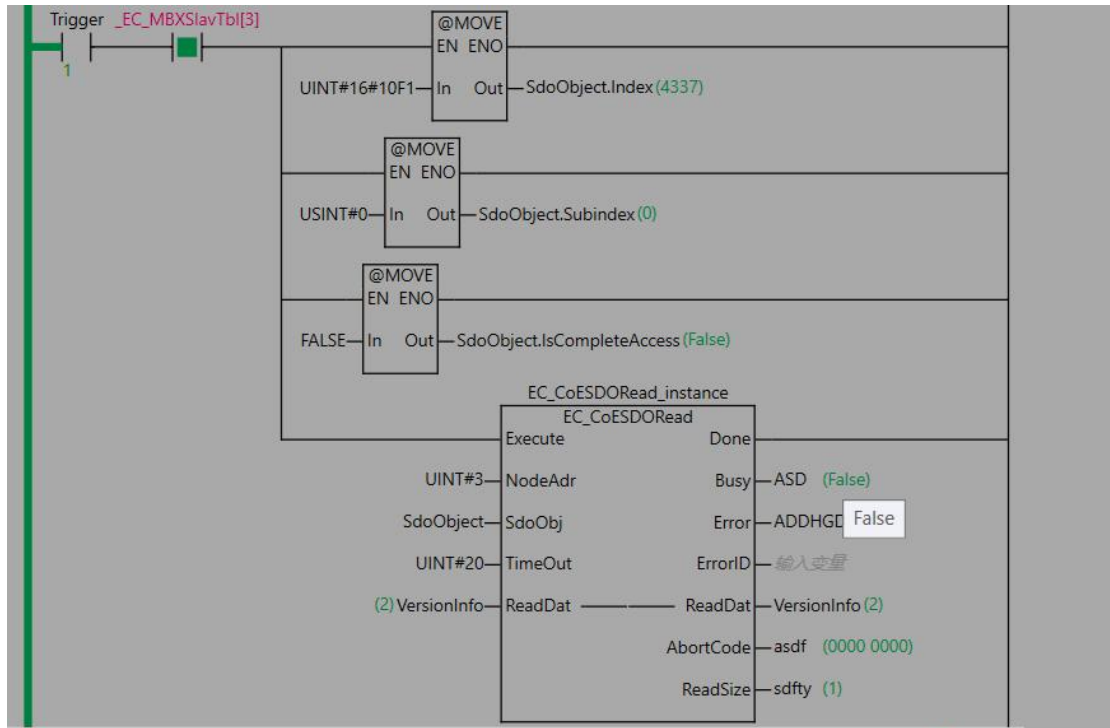

The contacts are connected, and the input object dictionaries are read and written respectively. Abortcode is displayed as 0 after reading and writing is successful.

10.3 Beckhoff series PLC (TWINCAT) and VH5/VH6

10.3.1 System configuration

Name	Model	Quantity	Explanation
Upper computer	TwinCAT	1	Beckhoff upper computer software
Controller	CX5120	1	-
Communication card	VHX-CC100	1	-
Network cable	JC-CB-3	some	For connection between devices

10.3.2 Parameter setting

The frequency converter slave station needs to be configured as EtherCAT communication mode, and the parameters to be modified are as follows:

Parameter	Name	Access	Set value	Range	Explanation
P0-02	Operation command channel selection	Runtime read only	2	0-2	Communication
P0-03	Main frequency A input channel selection	Runtime read only	6	0-9	Communication setting
P9-00	Communication protocol	Runtime read only	1	0-2	EtherCAT
P9-12	Slave station No.	RW	-	0-65535	After modification, it is valid when power on again.

10.3.3 Setup steps

1) Add XML file

Before opening the software operation, we need to copy the XML file to the TwinCAT installation directory, and the default path is c:\twincat\3.1\config\io\ethercat.

2) New project

Open the upper computer software TwinCAT.

File—New—Project:

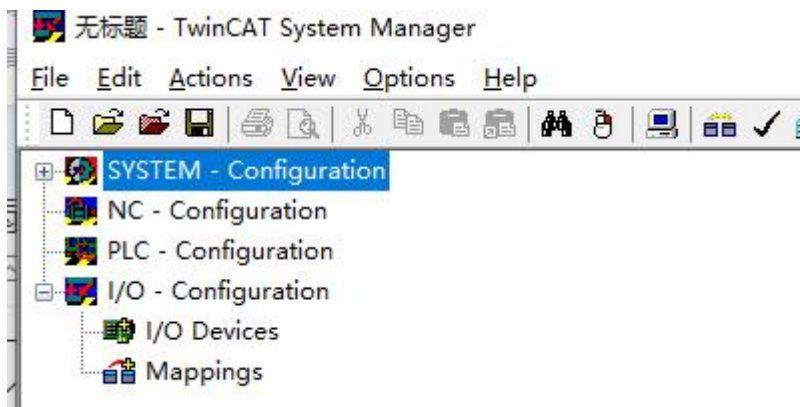

3) Master station connection configuration:

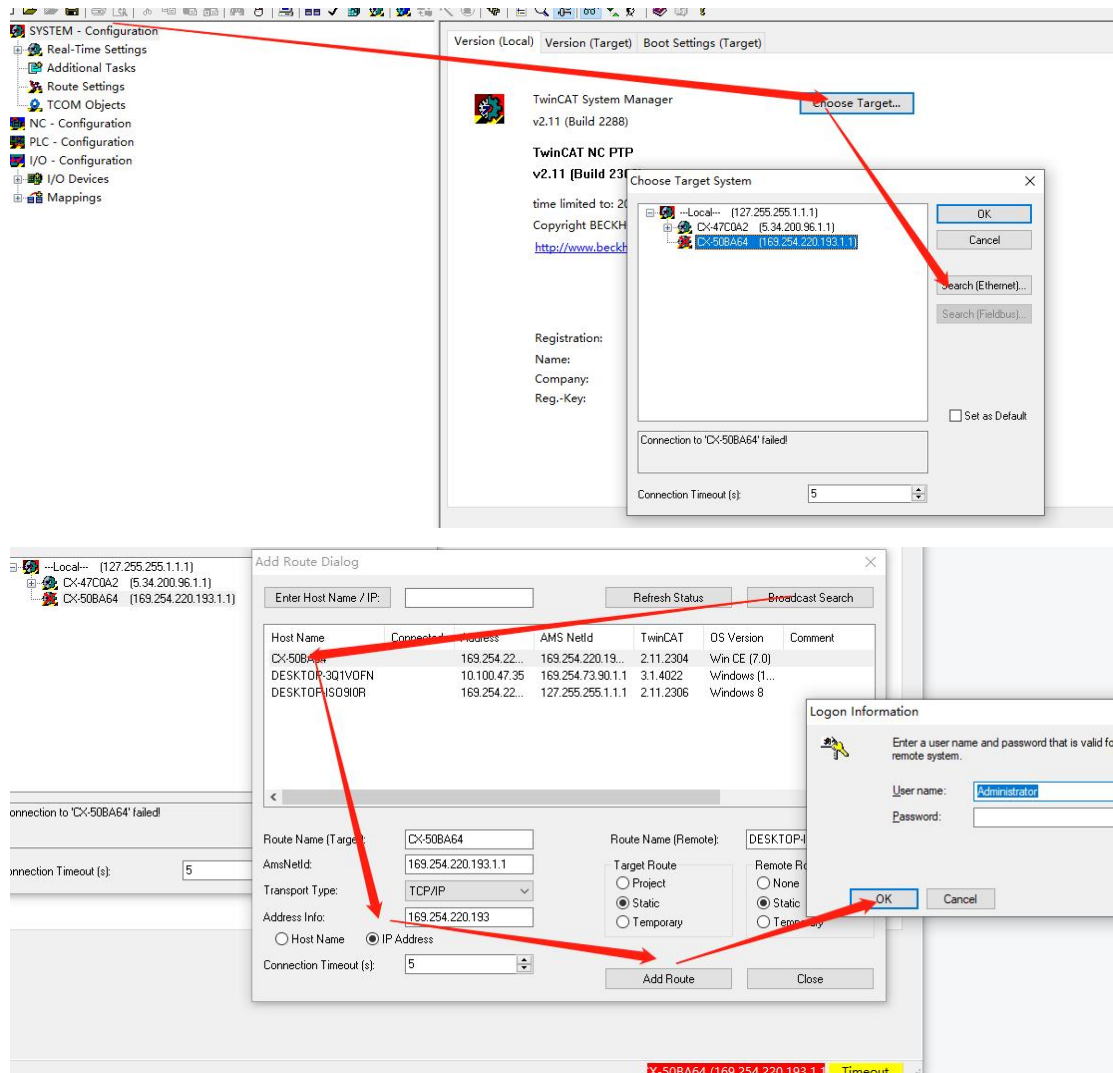

Connection complete.

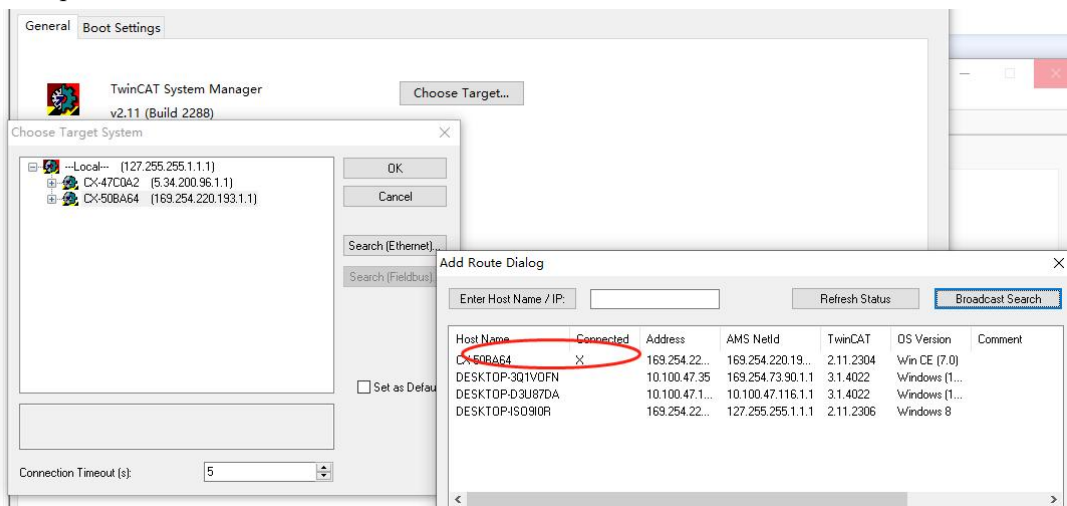

At this time, if the controller is not in config mode, you need to click this icon  to switch the controller to config mode first, and then right-click Device and click Scan to scan the slave station of EtherCAT.

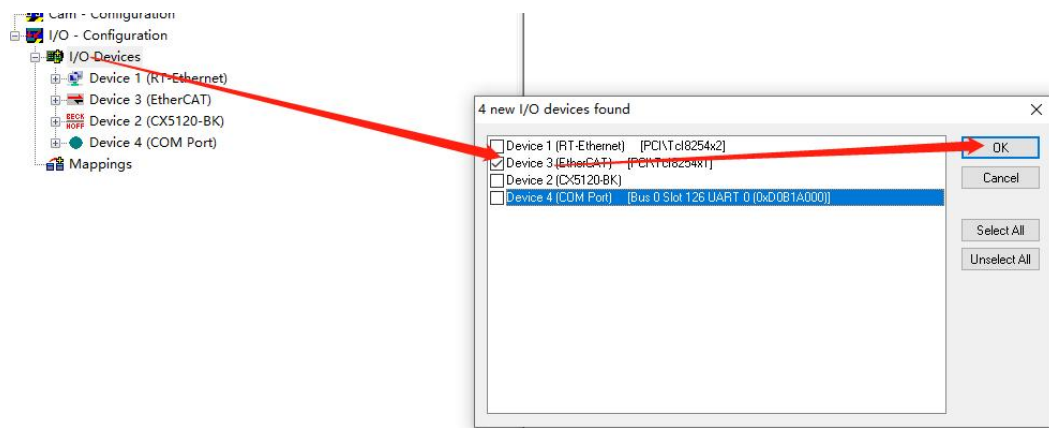

The scanning results are as follows:

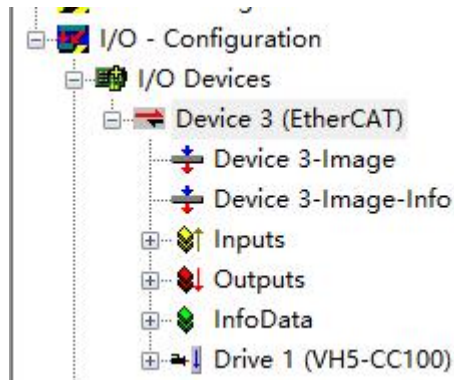

4) Configure activation

Click , Activate configuration

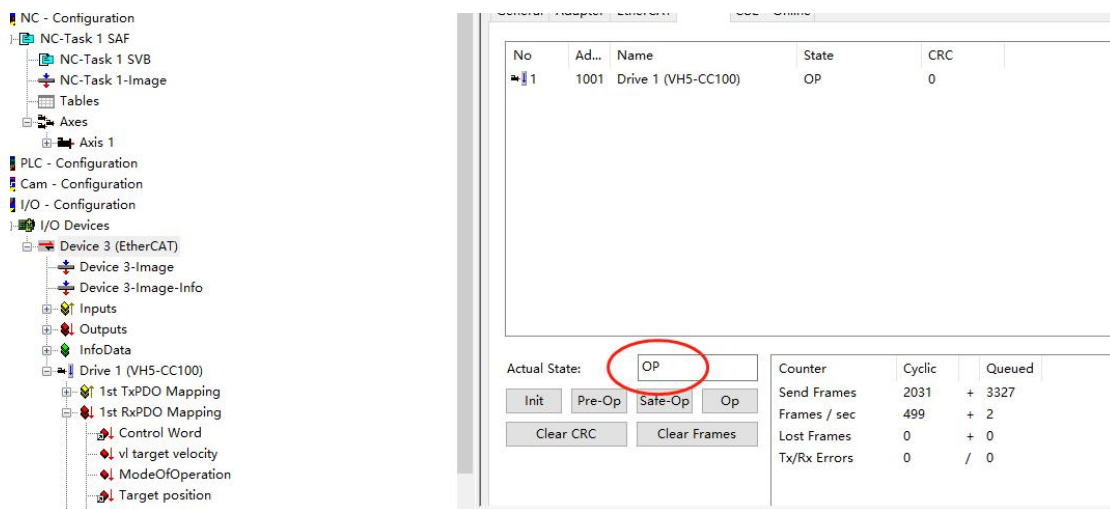

Click online, and the current state is the running state, indicating that the activation is correct.



5) Add Group U parameters to the PDO.

As shown in the following figure: click Drive 1 (VH5-CC100), select Process Data, click 0x1A00 in PDO list, and right-click in PDO content to insert U0-00 parameter.

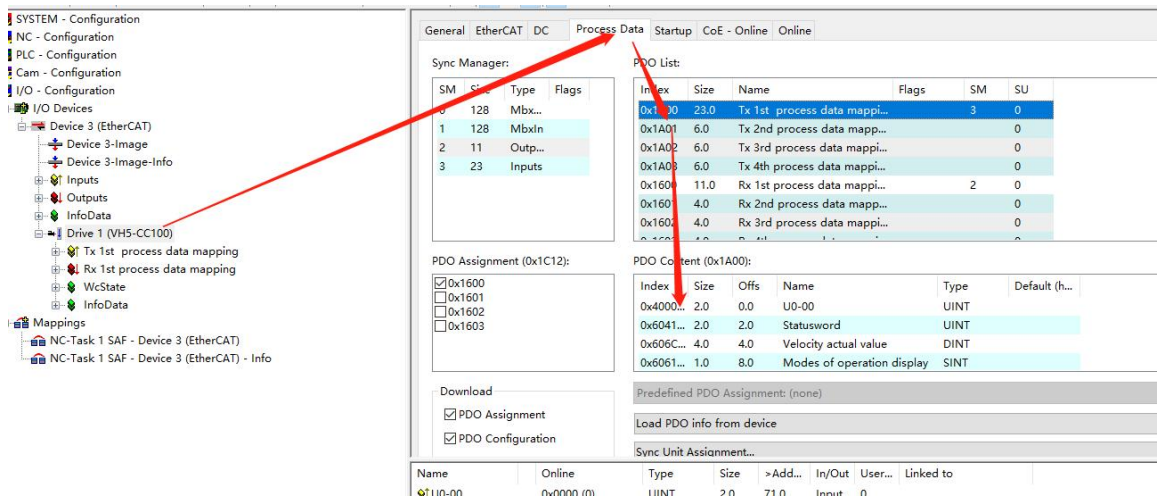

In config mode, add PDO data. As shown in the above figure, it was added successfully.

6) PDO data read/write(enable and speed setting)

As shown in the figure below, the object words 6040h and 6042h are written successfully.

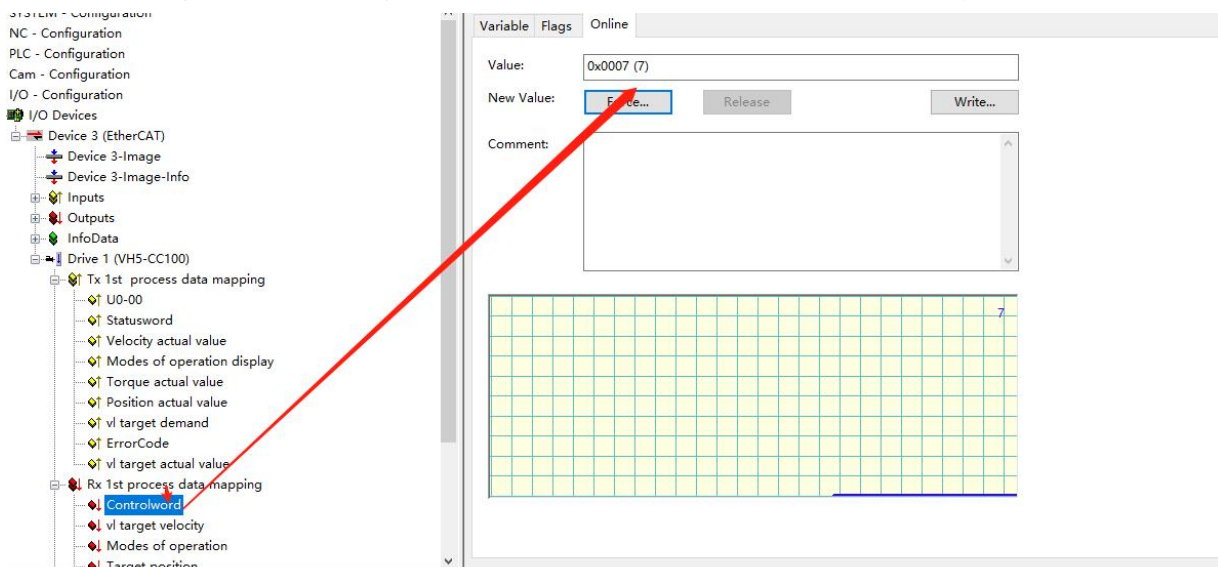

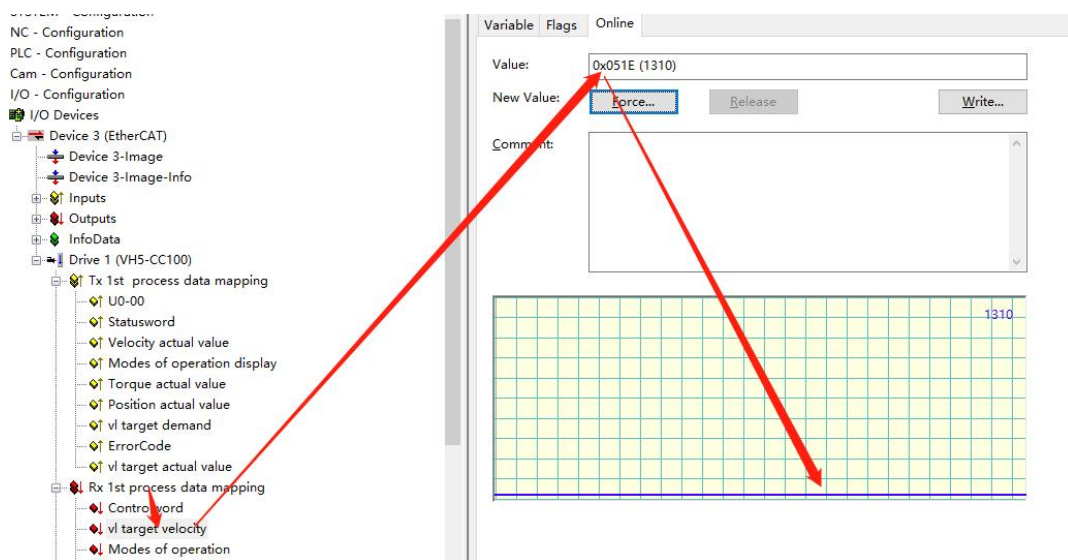

Set **【6040h: Control word】** : write 6 → 7 → 15 enable. 15 → 7 turn off enable. Write 128 to clear the frequency conversion alarm.

Set **【6042h:vl target velocity】**, for example, write 1000, P0-13=50Hz. The frequency converter operates with 5Hz forward rotation, writes -1000, and the frequency converter operates with 5Hz reverse rotation.

7)SDO data read/write

As shown in the following figure, the COE object dictionary 10F1 is read and written. The value of 10F1-01 is written from 1 to 3, and the value of 10F1-02 is written from 4 to 3. The writing and reading is successful.

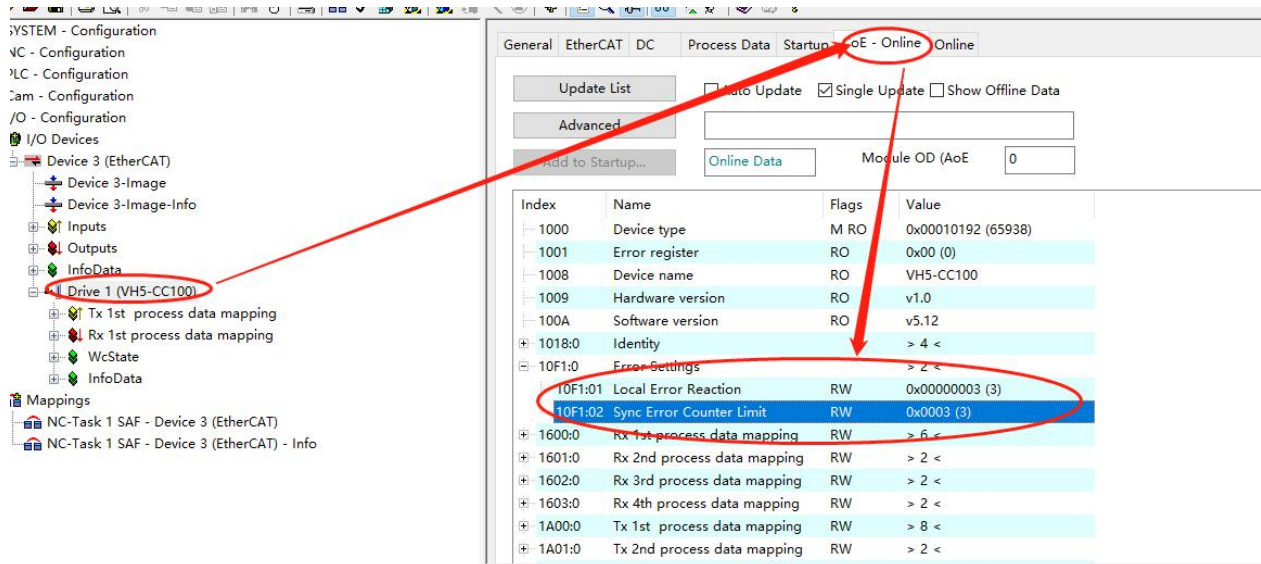

10.4 Inovance AM600 (CODESYS) and VH5/VH6

10.4.1 System configuration

Name	Model	Quantity	Explanation
Upper computer	InoProShop	1	Inovanceupper computer software
Controller	AM600	1	-
Communication card	VHX-CC100	1	-
Cable	JC-CB-3	some	For connection between computer and PLC and between PLC and VFD

10.4.2 Parameter setting

The frequency converter slave station needs to be configured as EtherCAT communication mode, and the parameters to be modified are as follows:

Parameter	Name	Access	Set value	Range	Explanation
P0-02	Operation command channel selection	Runtime read only	2	0-2	Communication
P0-03	Main frequency A input channel selection	Runtime read only	6	0-9	Communication setting
P9-00	Communication protocol	Runtime read only	1	0-2	EtherCAT
P9-12	Slave station No.	RW	-	0-65535	After modification, it is valid when power on again.

10.4.3 Setup steps

1) New project

Open the software InoProShop. Select "new project", select the model: AM600-CPU1608TP/TN in the project attribute interface, define the name and select the save path, and click "OK" to generate the programming interface.

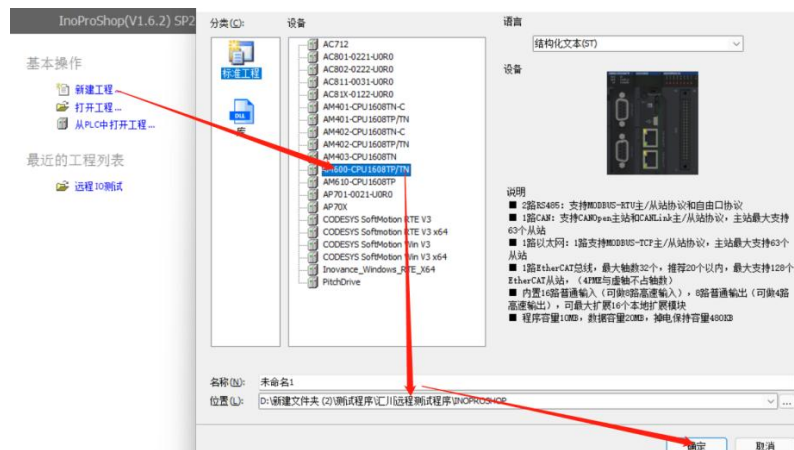

2)Hardware configuration

Double click the "CPU rack" item on the left to enter the hardware configuration screen of PLC mainframe:

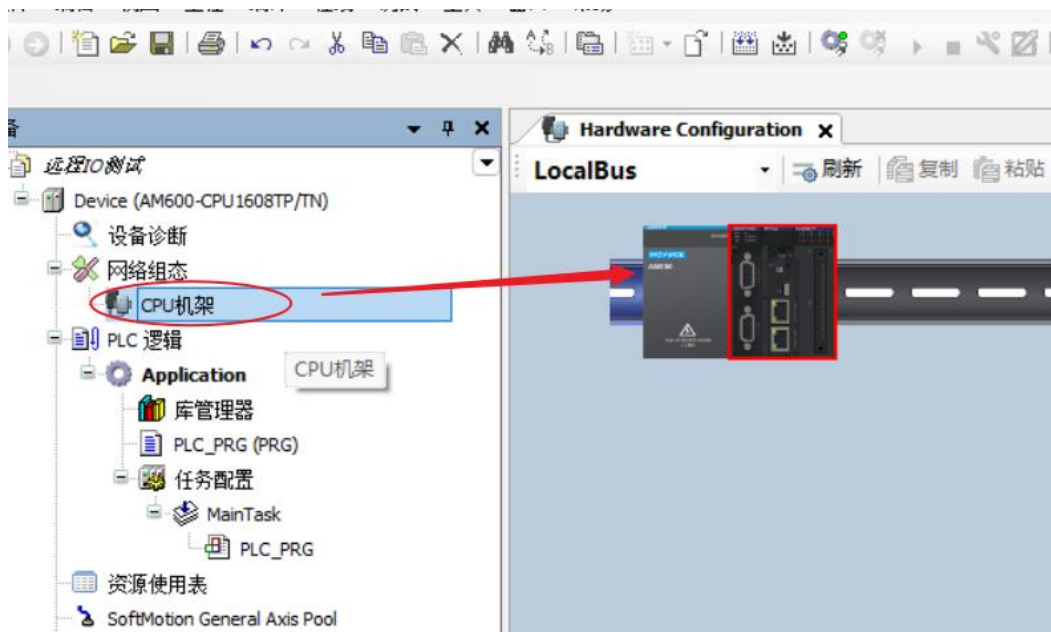

- ① Double click to enter the local expansion module configuration interface.
- ② Expansion module component library.
- ③ Select the position on the right side of the CPU unit on the installation slot, and in the expansion module component library, double-click to select the required IO modules and place them in order.

According to the module model and installation sequence used by the actual application system, double-click the selected module from the expansion module library on the right, and drag it to the "installation rack".

To delete a module, select the module and press Del to delete it. Take AM600 as an example, up to 16 expansion modules can be connected to the mainframe, including 8 analog modules.

3)Add XML file

- ① Install in the network configuration interface.

Click "import ECT file", and the following dialog box will pop up:

Select the XML file of the corresponding device and click "open".

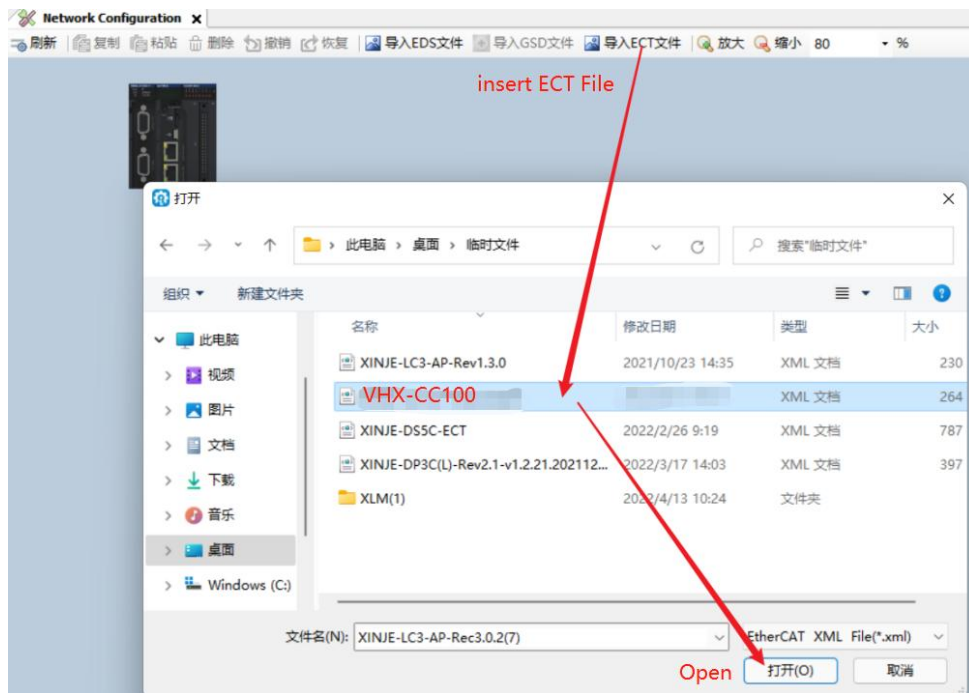

② Install through menu tools.

Choose Tool-Device library

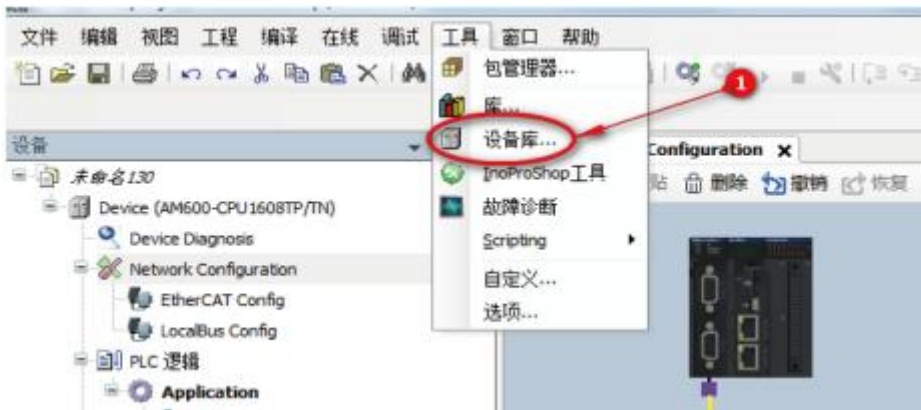

Select "Install" in the pop-up dialog box.

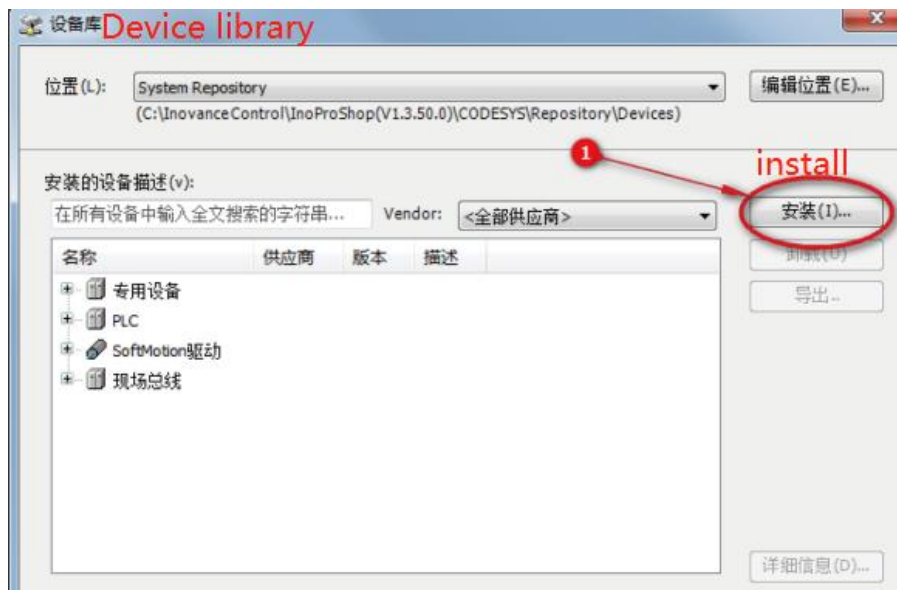

Select the "EtherCAT XML device description configuration file" item in the pop-up "install device description"

dialog box, select the slave device description file saved in the local path, and open the corresponding XML file.

4) Add master device

It is recommended to use the scanning function and follow the **【hot reset】-【log out】-【scanning device】** process.

Preparation conditions:

① The PC and PLC are correctly connected through the gateway, search the PLC in the same network segment, and click OK after finding it.

Note: Ethernet connection requires that the IP address of the connecting device (PC) and the IP address of the PLC are in the same network segment, so confirm whether the IP address setting of the PC meets the requirements before making the connection action.

The following figure:

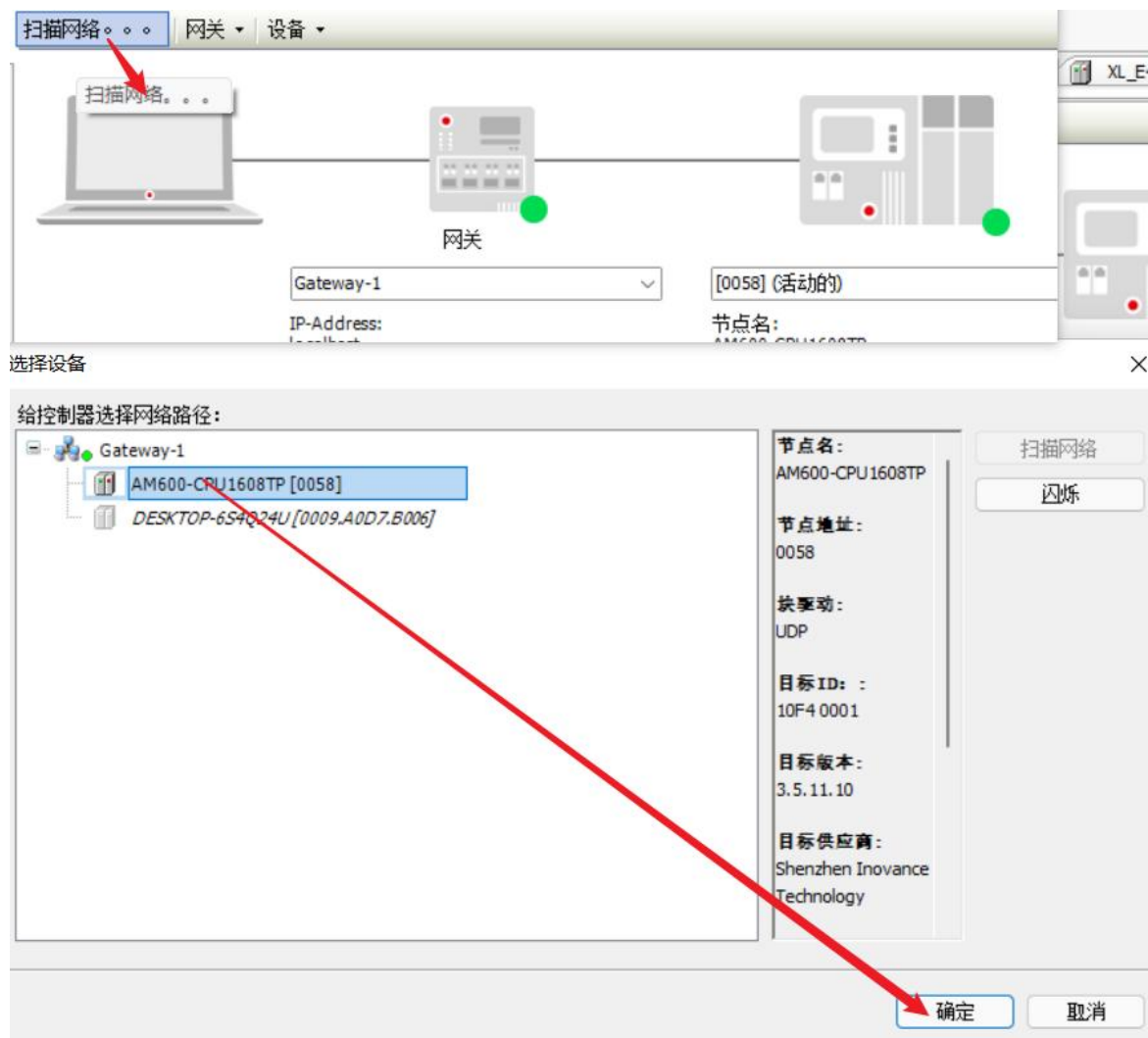

② PLC and slave networking are normal.

③ The configuration information of the background configuration port is consistent with the actual PLC connection port, as shown in the following figure.

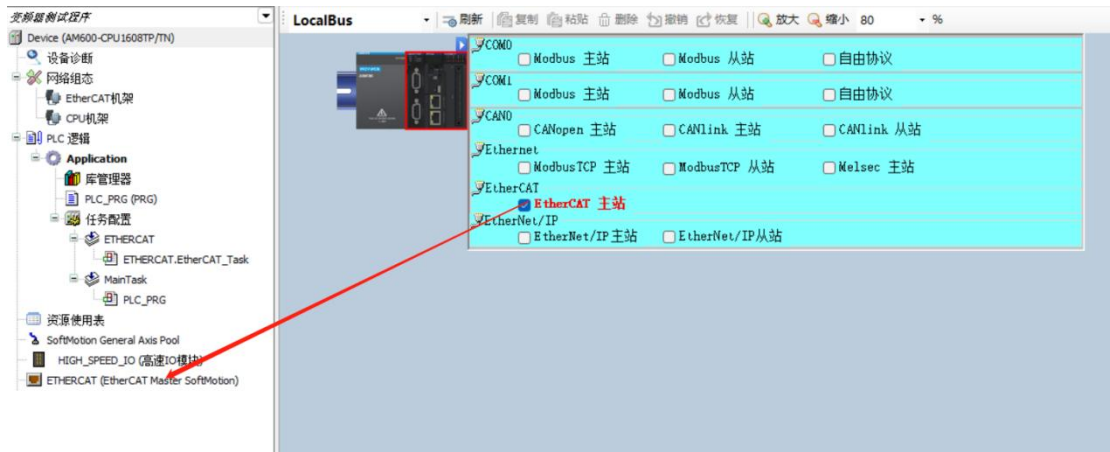

5) Set master station parameters

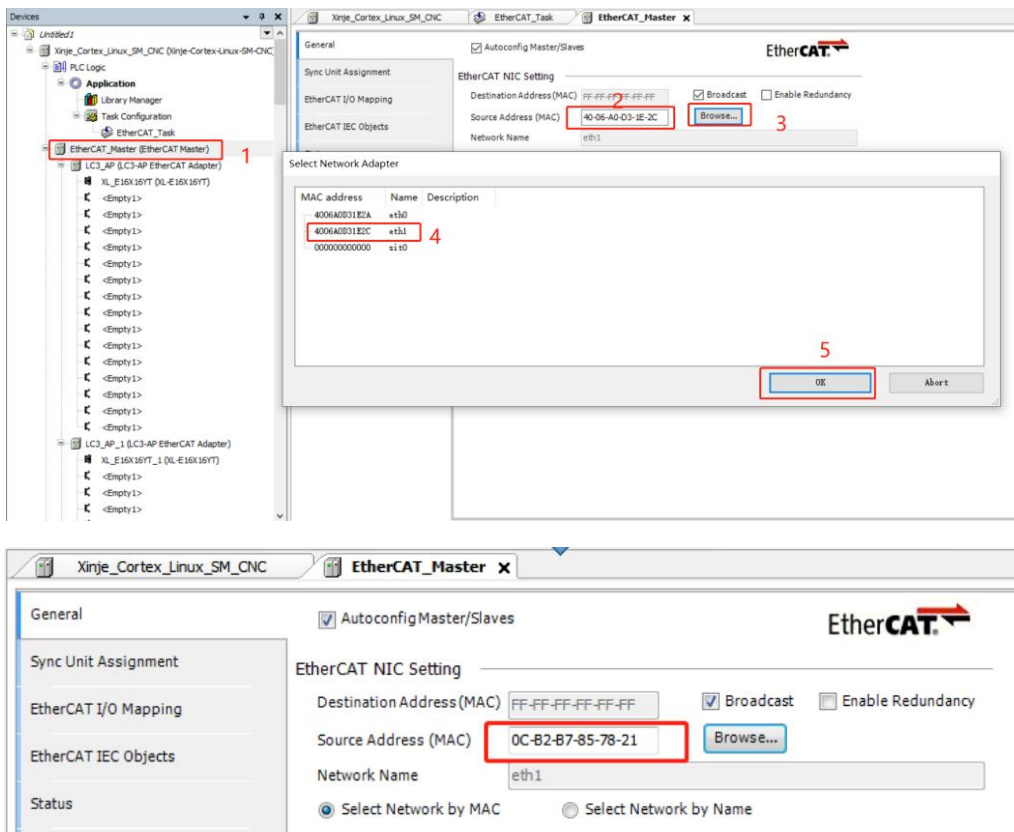

6) Scan slave station

After the configuration information of the background configuration port is consistent with the actual PLC connection port, scan the EtherCAT slave device.

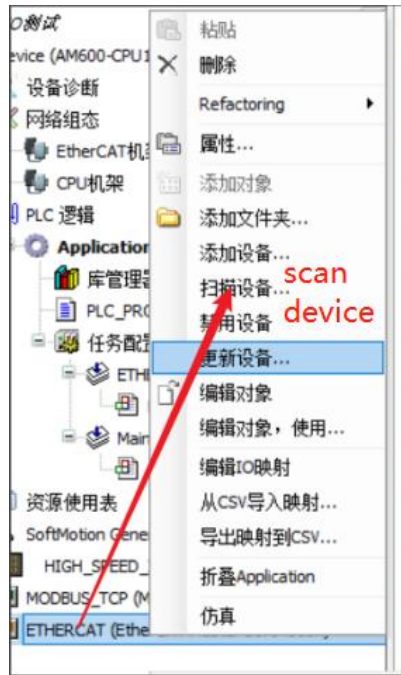

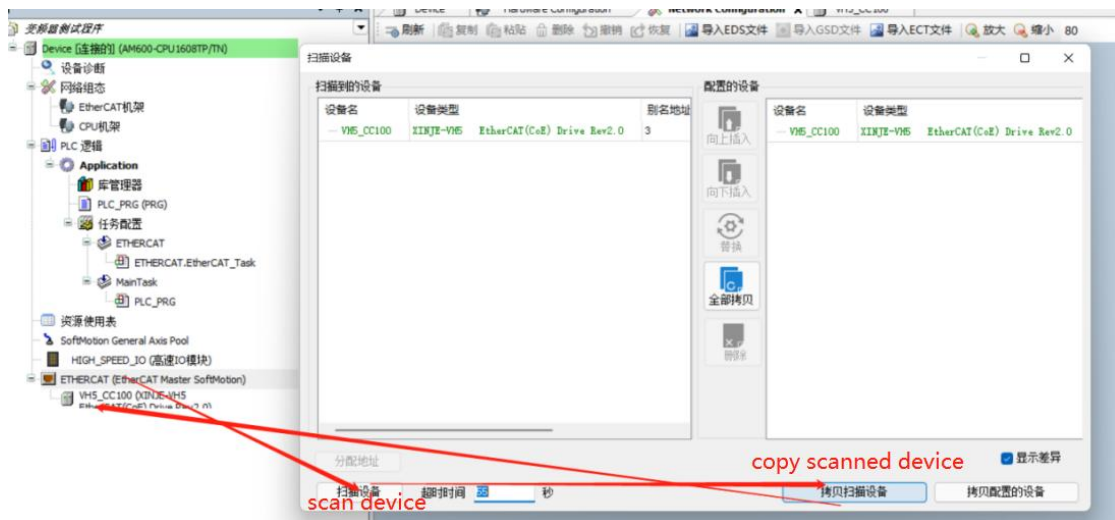

The scanning results are shown in the figure below. Click Copy scanned device to add all the scanned slave stations to the project.

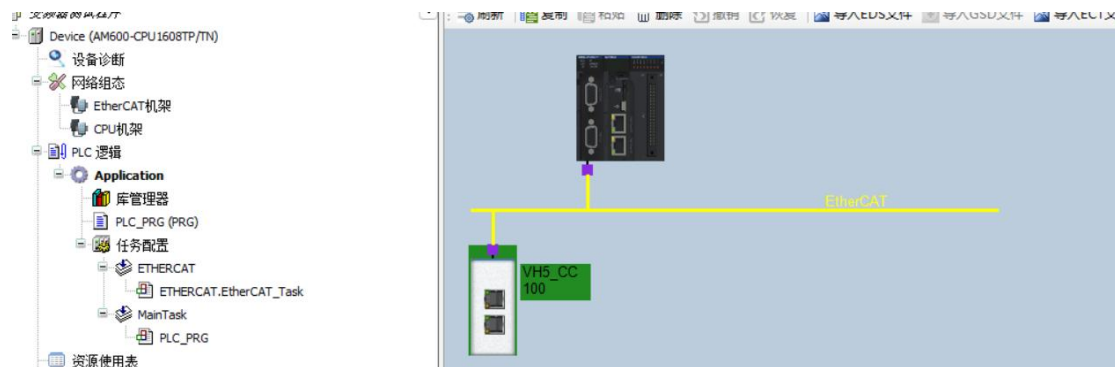

The network configuration is shown as follows:



7) Configure activation

Compile  and download the configuration in turn, log in  and run  the PLC.

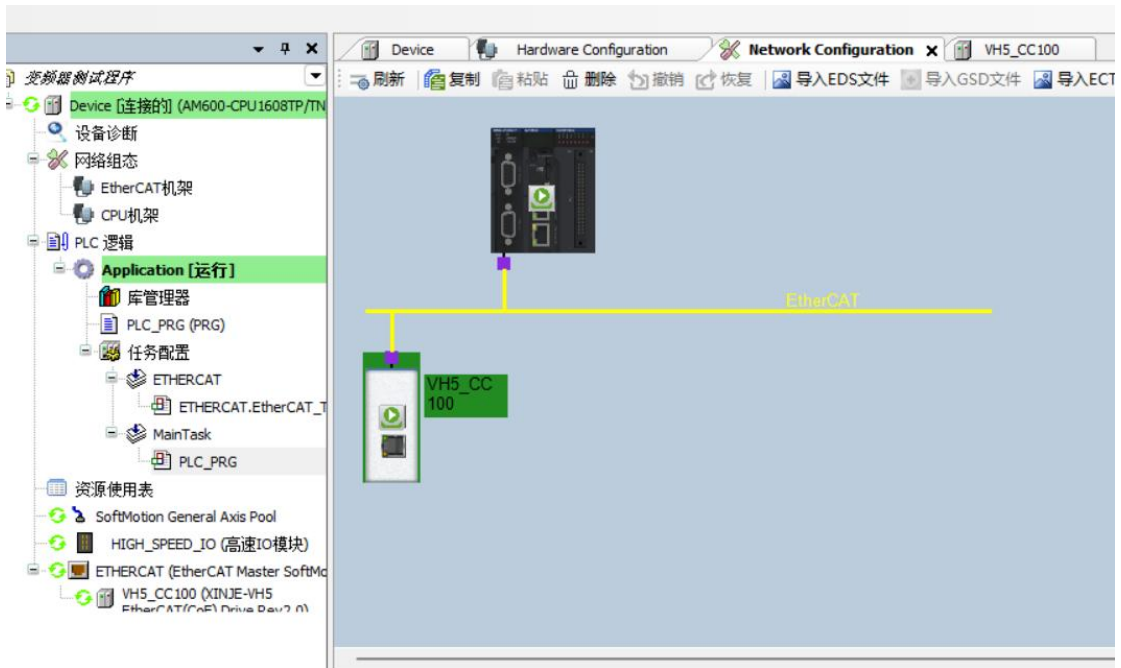

Click online, and the current state is the running state, indicating that the activation is correct.

常规

过程数据(PDO设置)

启动参数(SDO设置)

在线 **Online**

在线CoE

EtherCAT I/O映射

状态

信息

设备状态

初始化 引导状态 **Current state: running**

预运行 安全运行 当前状态: **运行**

运行 清除错误 请求状态: **运行**

FoE

下载... 上传...

E²PROM接口

写E²PROM... 读 E²PROM... 写入E²PROM XML

8) Add Group U parameters to the PDO.

常规

过程数据(PDO设置)

启动参数(SDO设置)

在线

在线CoE

EtherCAT I/O映射

状态

信息

增加 删除 全部折叠 全部显示

加载PDO PDO分配 PDO配置 PDO数据大小 输出(字节): 11.0 输入(字节): 23.0

名称	索引	子索引	长度	类型	标志	SM
1st RxPDO Mapping	16#1600	16#00	11.0			
Control Word	16#6040	16#00	2.0	UINT	可编辑	2
vl target velocity	16#6042	16#00	2.0	INT		
ModeOfOperation	16#6060	16#00	1.0	SINT		
Target position	16#607A	16#00	4.0	DINT		
Target torque	16#6071	16#00	2.0	INT		
Rx 2nd process data mapping	16#1601	16#00	4.0		可编辑	
Rx 3rd process data mapping	16#1602	16#00	4.0		可编辑	
Rx 4th process data mapping	16#1603	16#00	4.0		可编辑	
1st TxPDO Mapping	16#1A00	16#00	23.0			3
00-00	16#4000	16#00	2.0	UINT		
Status Word	16#6041	16#00	2.0	UINT		
Velocity actual value	16#606C	16#00	4.0	DINT		
ModeOfOperationDisplay	16#6061	16#00	1.0	SINT		
Torque actual value	16#6077	16#00	2.0	INT		
Position actual value	16#6064	16#00	4.0	DINT		
vl target demand	16#6043	16#00	4.0	DINT		
ErrorCode	16#603F	16#00	2.0	UINT		
vl target actual value	16#6044	16#00	2.0	INT		
Tx 2nd process data mapping	16#1A01	16#00	6.0		可编辑	
Tx 3rd process data mapping	16#1A02	16#00	6.0		可编辑	
Tx 4th process data mapping	16#1A03	16#00	6.0		可编辑	
输入	16#0000	16#00	0.0		可编辑	

Add PDO data without login. As shown in the above figure, it is added successfully.

9)PDO data read/write(enable and speed setting)

变量	映射	通道	地址	类型	默认值	当前值	准备值	单位	描述
Control Word			%QW2	UINT	128	6			Control Word
vl target velocity			%QW3	INT	0				vl target velocity
ModeOfOperation			%QB8	SINT	0				ModeOfOperation
Target position			%QD3	DINT	0				Target position
Target torque			%QW8	INT	0				Target torque
U0-00			%IW2	UINT	0				U0-00
Status Word			%IW3	UINT	4688				Status Word

变量	映射	通道	地址	类型	默认值	当前值	准备值	单位	描述
Control Word			%QW2	UINT	6				Control Word
vl target velocity			%QW3	INT	5000				vl target velocity
ModeOfOperation			%QB8	SINT	0				ModeOfOperation
Target position			%QD3	DINT	0				Target position
Target torque			%QW8	INT	0				Target torque
U0-00			%IW2	UINT	0				U0-00
Status Word			%IW3	UINT	4657				Status Word

As shown in the figure above, the object words 6040h and 6042h are written successfully.

Set **【6040h: Control word】** : write 6 → 7 → 15 enable. 15 → 7 turn off enable. Write 128 to clear the frequency conversion alarm.

Set **【6042h:vl target velocity】**, for example, write 1000, P0-13=50Hz. The frequency converter operates with 5Hz forward rotation, writes -1000, and the frequency converter operates with 5Hz reverse rotation.

10)SDO data read/write

As shown in the following figure, the COE object dictionary 10F1 is read and written. The value of 10F1-01 is written from 1 to 3, and the value of 10F1-02 is written from 4 to 3. The writing and reading is successful.

16#1009:16#00	Hardware version	RO	STRING(3)	'v1.0'
16#100A:16#00	Software version	RO	STRING(4)	'v5.12'
16#1018:16#00	Identity			
16#10F1:16#00	Error Settings			
:16#01	Local Error Reaction	RW	UDINT	1
:16#02	Sync Error Counter Limit	RW	UINT	4
16#1600:16#00	Rx 1st process data mapping	RW	USINT	5

10.5 Inovance H5U and VH5/VH6

10.5.1 System configuration

Name	Model	Quantity	Explanation
Upper computer	AutoShop	1	Inovance upper computer software
Controller	H5U	1	-
Communication card	VHX-CC100	1	-
Cable	JC-CB-3	some	For connection between computer and PLC and between PLC and VFD

10.5.2 Parameter setting

The frequency converter slave station needs to be configured as EtherCAT communication mode, and the parameters to be modified are as follows:

Parameter	Name	Access	Set value	Range	Explanation
P0-02	Operation command channel selection	Runtime read only	2	0-2	Communication
P0-03	Main frequency A input channel selection	Runtime read only	6	0-9	Communication setting
P9-00	Communication protocol	Runtime read only	1	0-2	EtherCAT
P9-12	Slave station No.	RW	-	0-65535	After modification, it is valid when power on again.

10.5.3 Setup steps

1)New project

Double click to open autoshop v4.4.6.0 software and create a new project:

- ① Executive document - new project;
- ② Select a new project, select H5U series, enter the project name and save path, click OK, then the project column will appear attribute explorer.

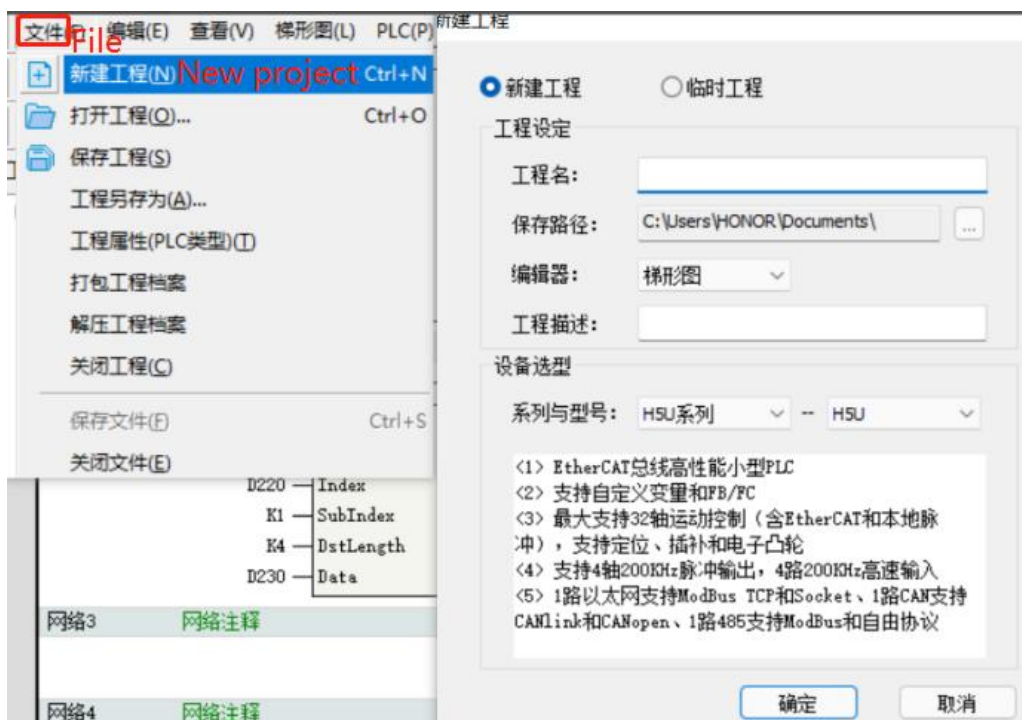

2) Add XML file

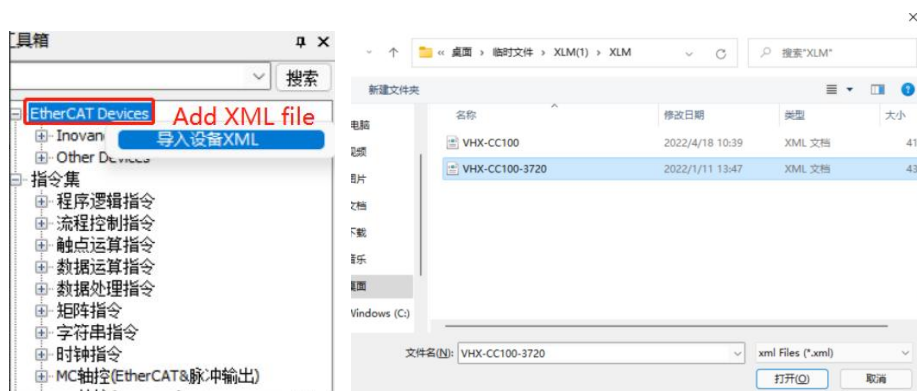

3) Master station connection configuration

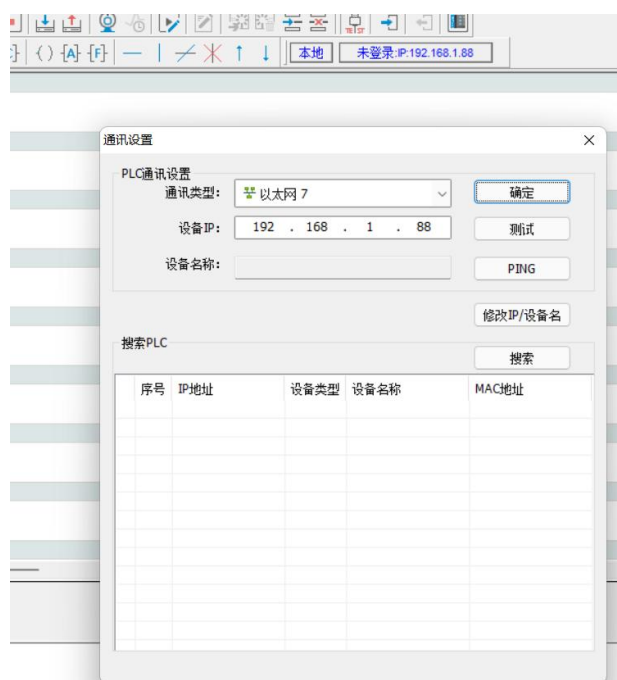

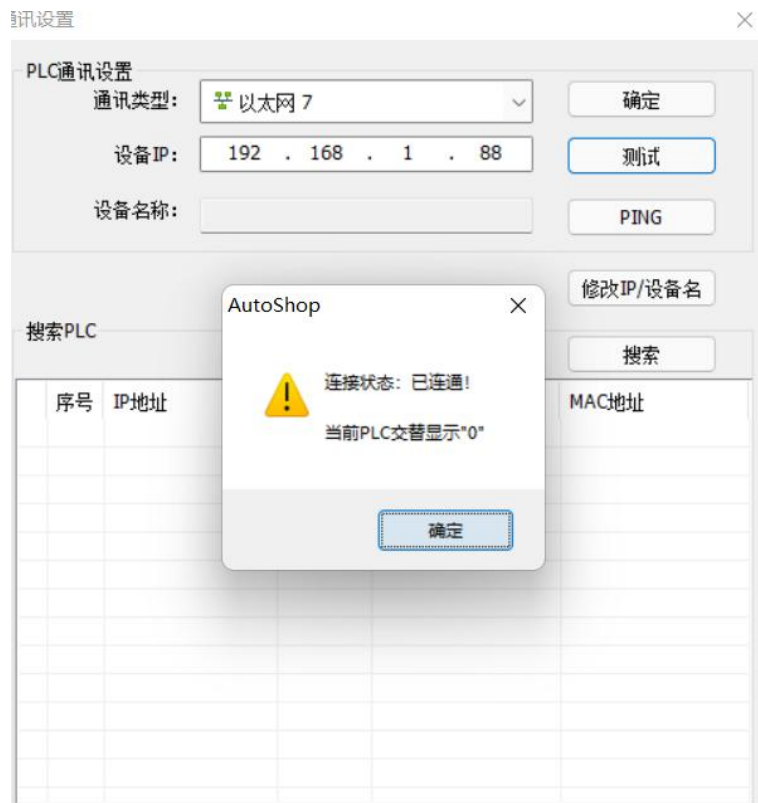

4) Add slave station



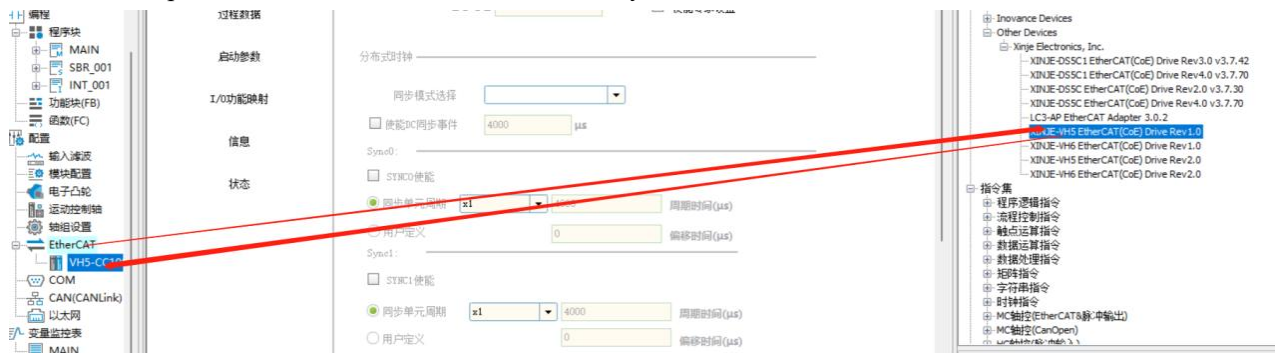

If the controller is not in the monitoring state, the frequency converter does not support automatic scanning of the slave station at present, and it needs to be added manually.

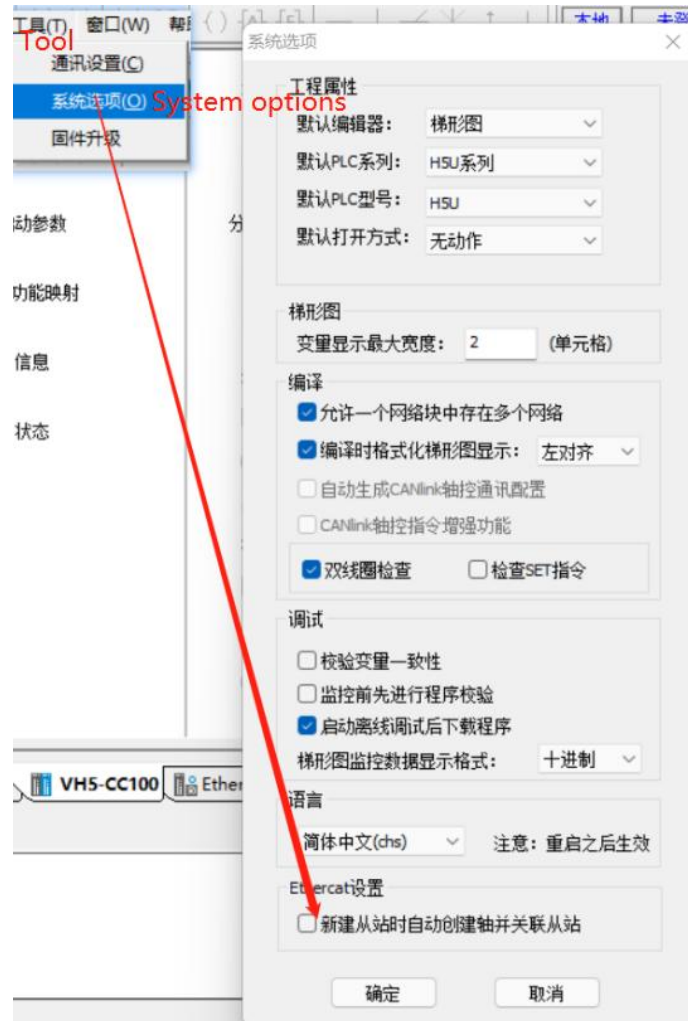

If you need to automatically add an axis, please check the following operation to automatically create an axis and associate the slave when creating a new slave station.



5) Activate configuration

- ① Click compile  to confirm whether the configuration and program are wrong, then download the configuration  and run it, and then monitor it .
- ② Click status to confirm that all slave state machines are in OP status.



6) Add Group U parameters to the PDO.

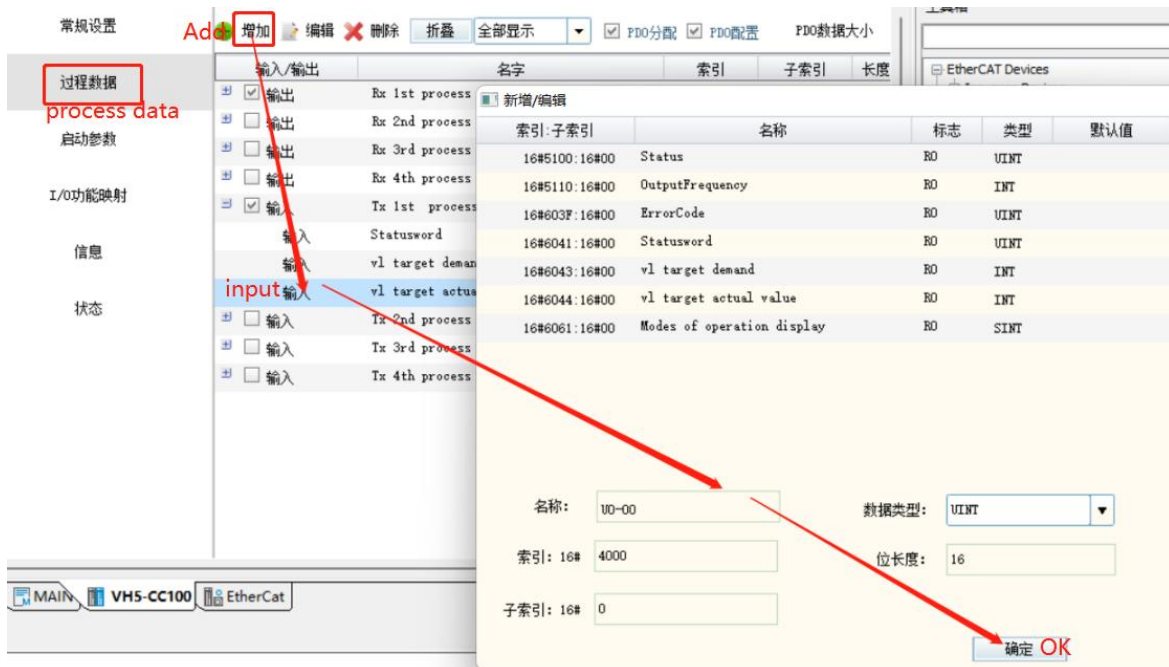

7) PDO data read/write(enable and speed setting)

Click IO function mapping to perform relevant operations on the required values.

Clear alarm:

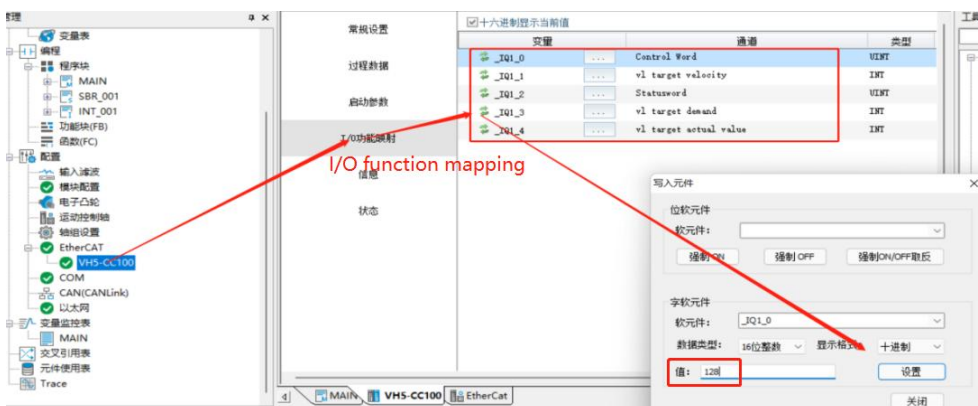

Set velocity:

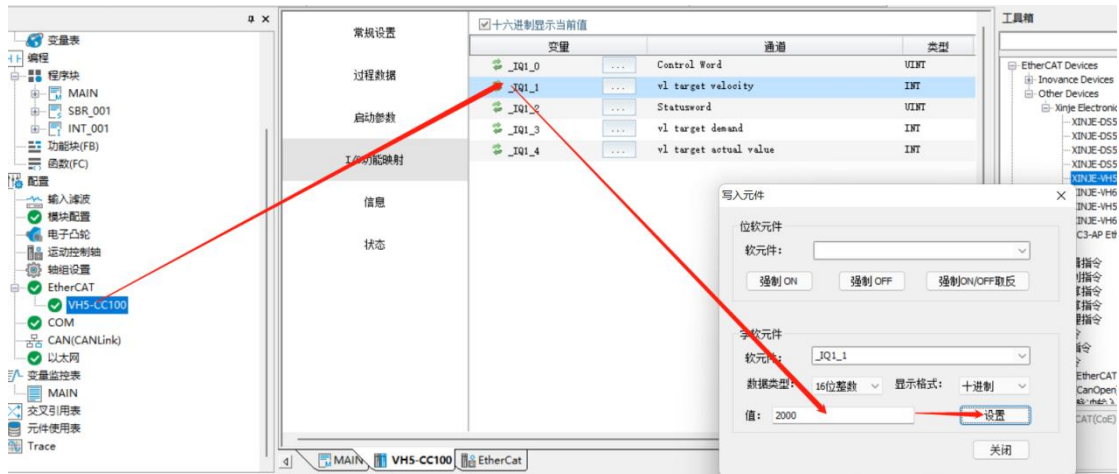

8) SDO data reading and writing

- ① Operate in sequence according to the steps written in the figure, and then read and write according to the required parameters.
- ② Note: the trigger condition of the command is normally on / off.
- ③ Read / write program.

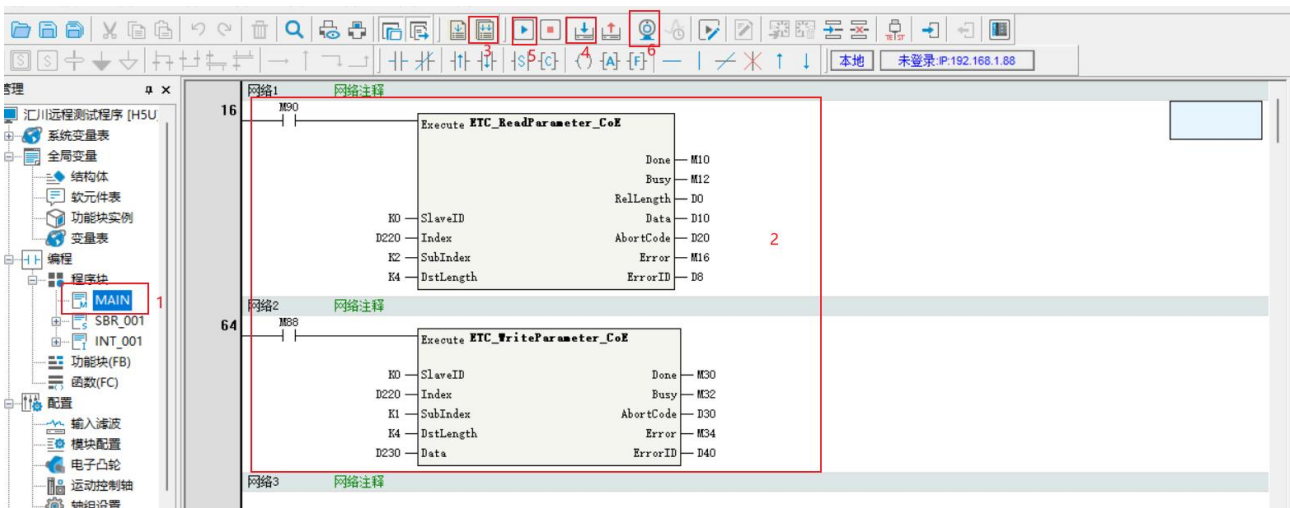

10.6 KEYENCE PLC KV 7300 and VH5/VH6

10.6.1 System configuration

Name	Model	Quantity	Explanation
Upper computer	KV STUDIO Ver.9G	1	Omron upper computer software
Controller	KV_7300 series	1	-
Communication card	VHX-CC100(V2.0)	1	-
Network cable	JC-CB-3	some	For connection between PLC and slave
USB cable	USB cable	-	For connection between computer and PLC

10.6.2 Parameter setting

The frequency converter slave station needs to be configured as EtherCAT communication mode, and the parameters to be modified are as follows:

Parameter	Name	Access	Set value	Range	Explanation
P0-02	Operation command channel selection	Runtime read only	2	0-2	Communication
P0-03	Main frequency A input channel selection	Runtime read only	6	0-9	Communication setting
P9-00	Communication protocol	Runtime read only	1	0-2	EtherCAT
P9-12	Slave station No.	RW	-	0-65535	After modification, it is valid when power on again.

10.6.3 Setup steps

1)New project

- ①The computer and PLC are connected and communicated through USB port.
- ②Open the software and create a new project.

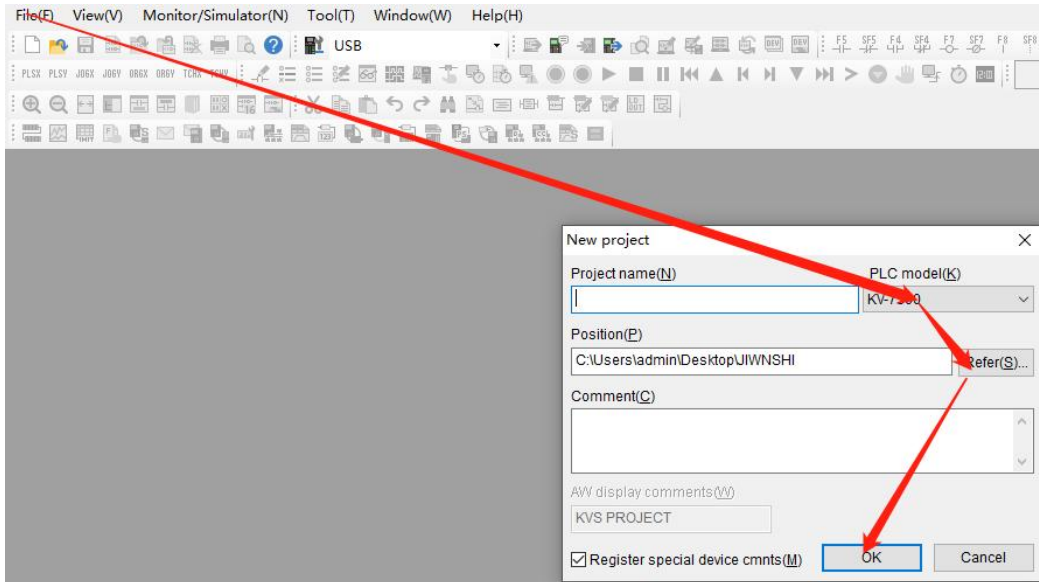

③Pop up the confirm unit configuration setting interface, and click "yes".

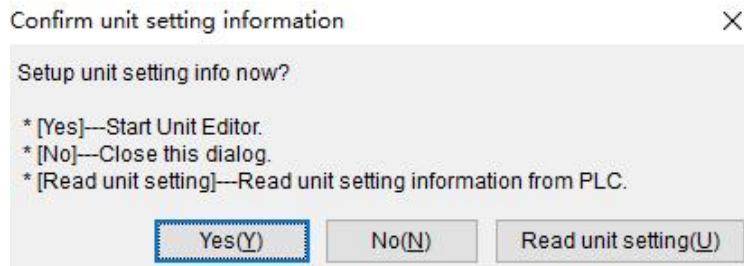

④Click the icon in the upper left corner: obtain the unit configuration information connected to the PLC, double-click the model "KV-7300" to open the unit editor.

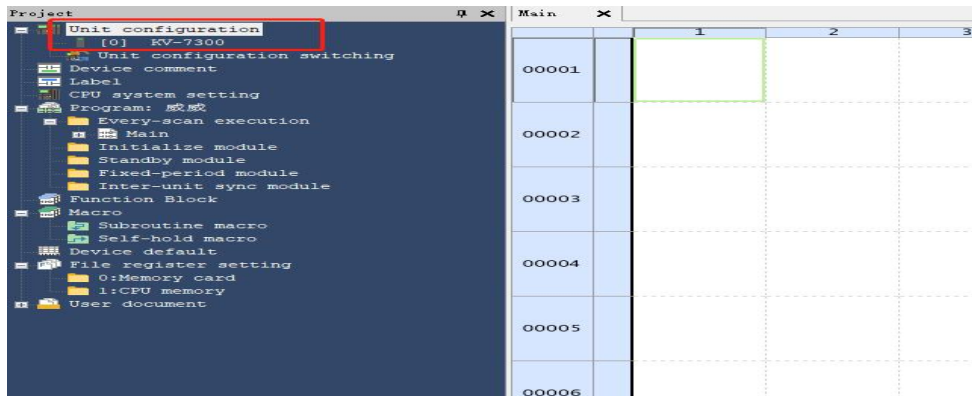

2)Get configuration information (master station connection)

① Click "get unit configuration information connected to PLC".

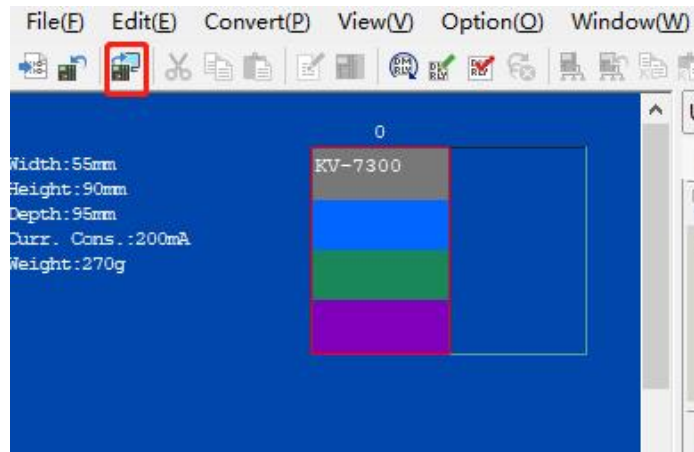

②Click OK.

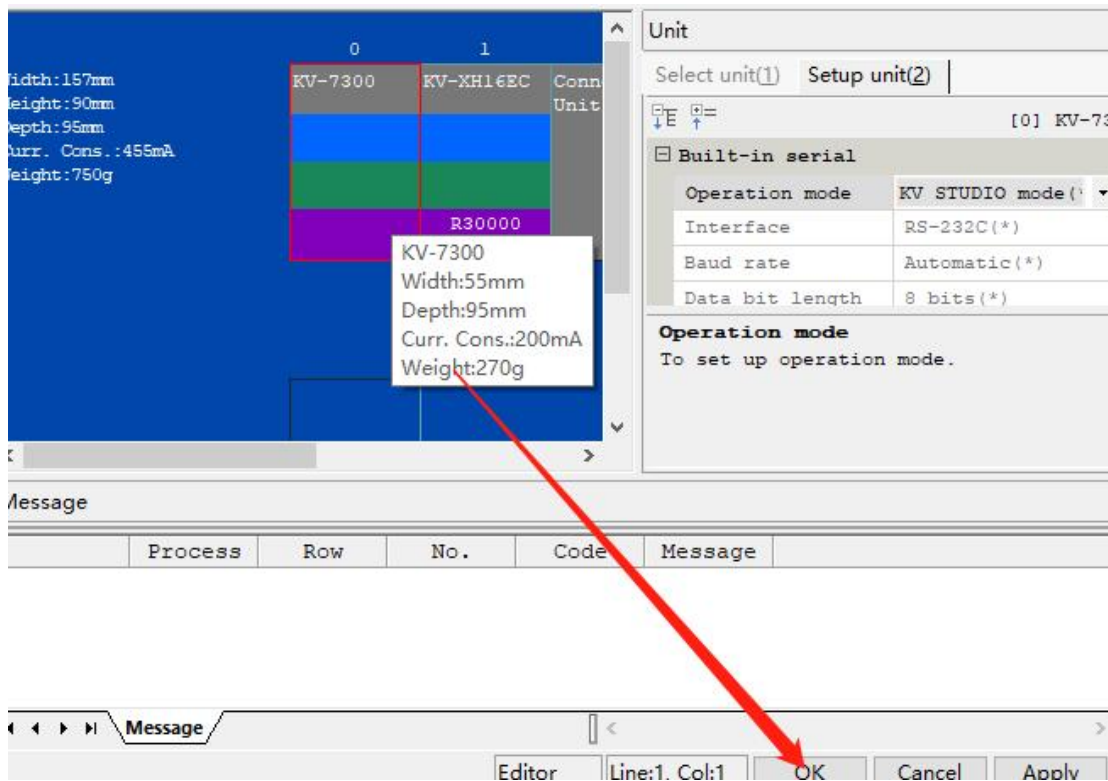

3)ESI file registration

Click "axis composition setting" and "ESI file registration".

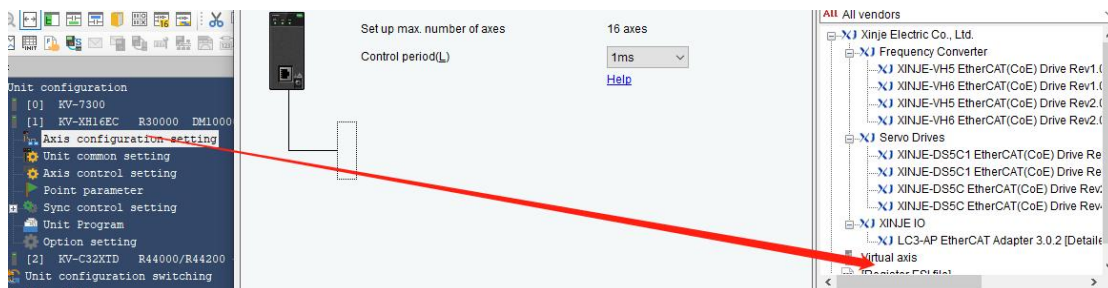

Select the XML file .

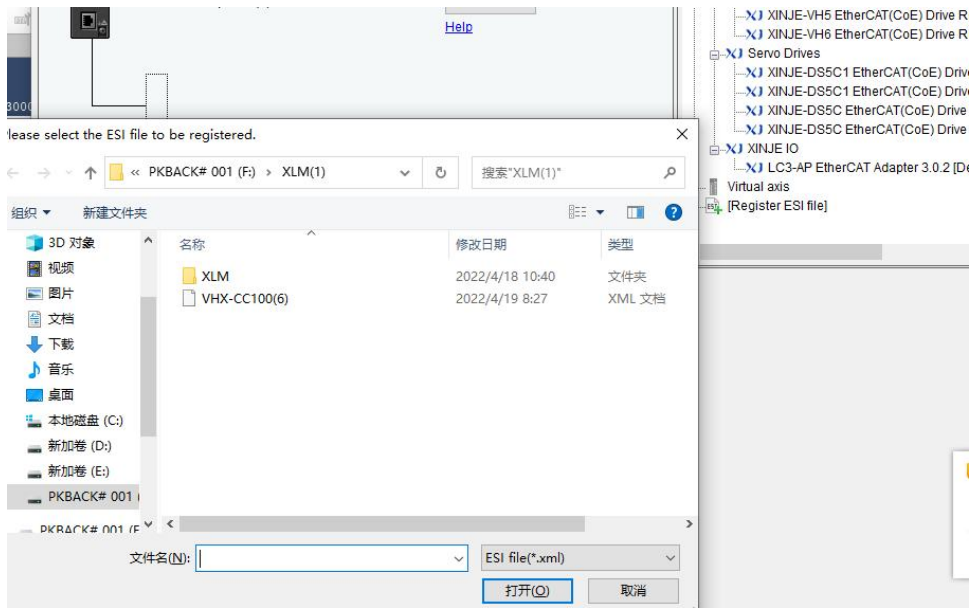

After adding successfully, it is shown in the following figure:



4) Add slave configuration

As shown in the figure below, double-click VH5 1.0 to add the first slave station, and a configuration interface will pop up after adding.

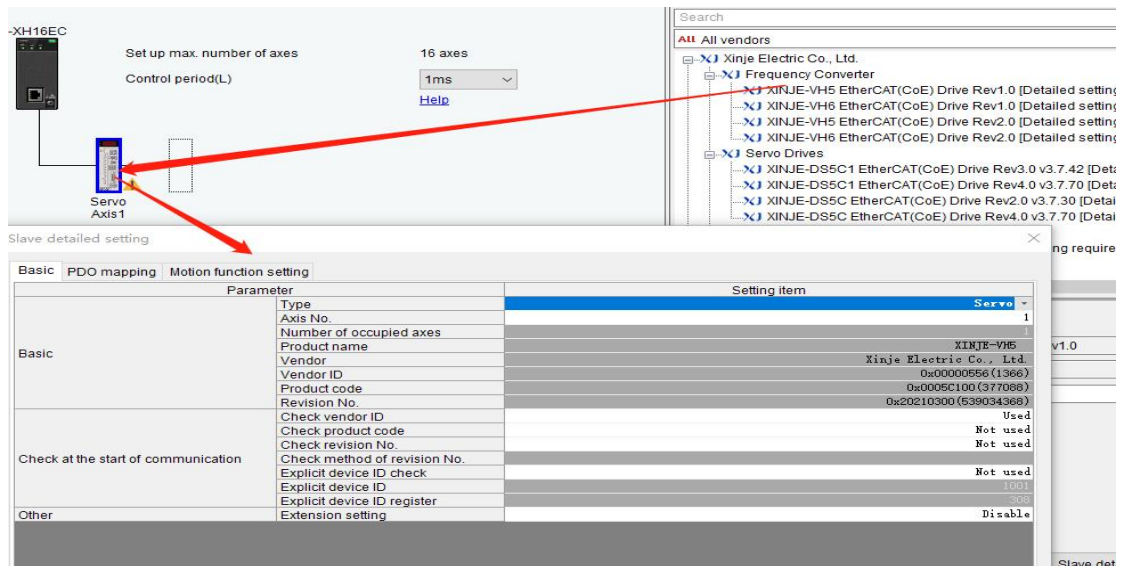

Select the extension settings, as shown in the following figure:

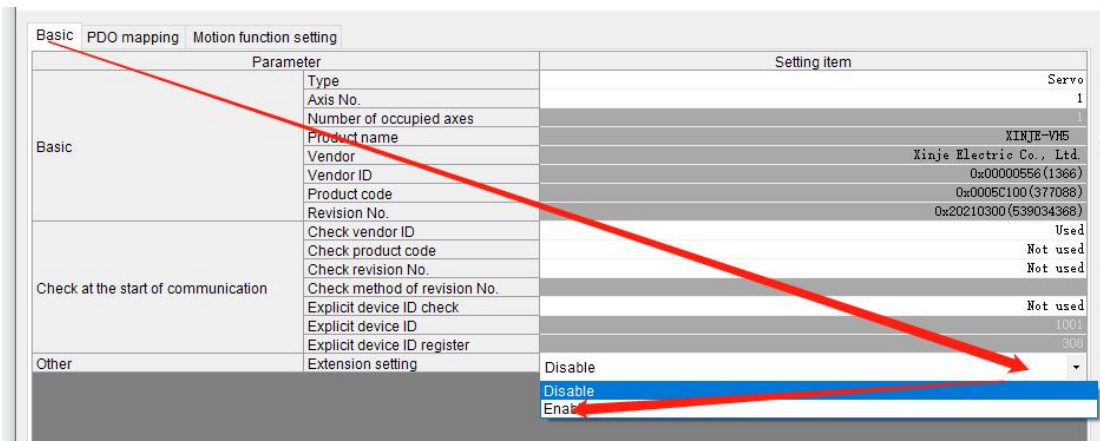

DC setting-choose DC mode

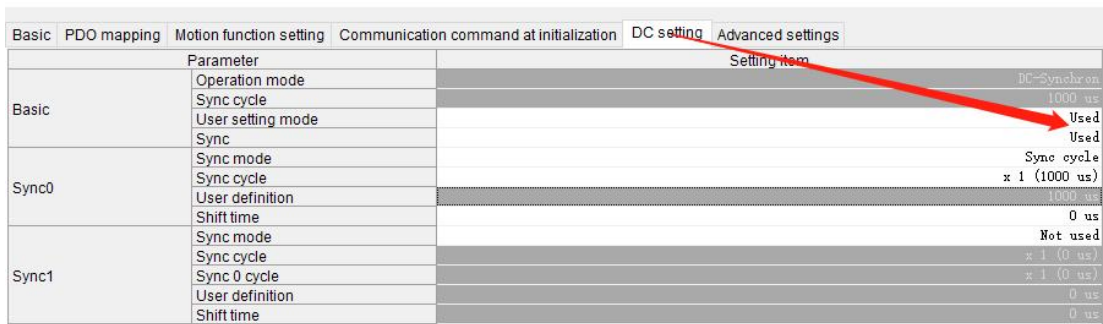

Select the operation mode supported by the slave station of the EtherCAT connection object.

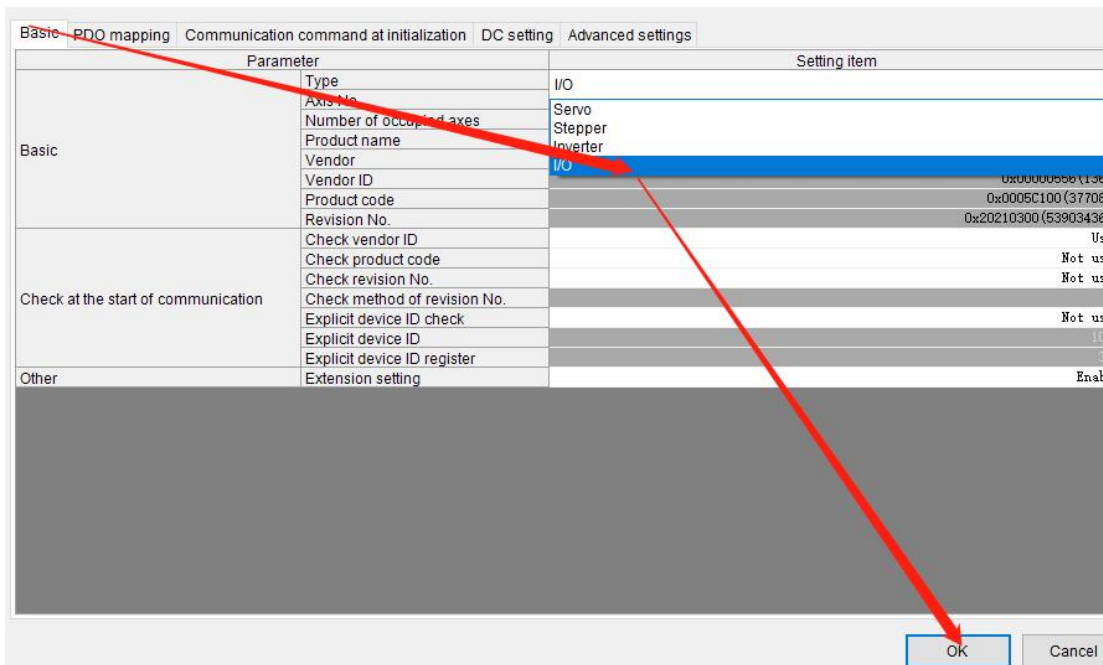

5) Add PDO mapping

Add the required PDO parameters, including input and output, as shown in the figure below.

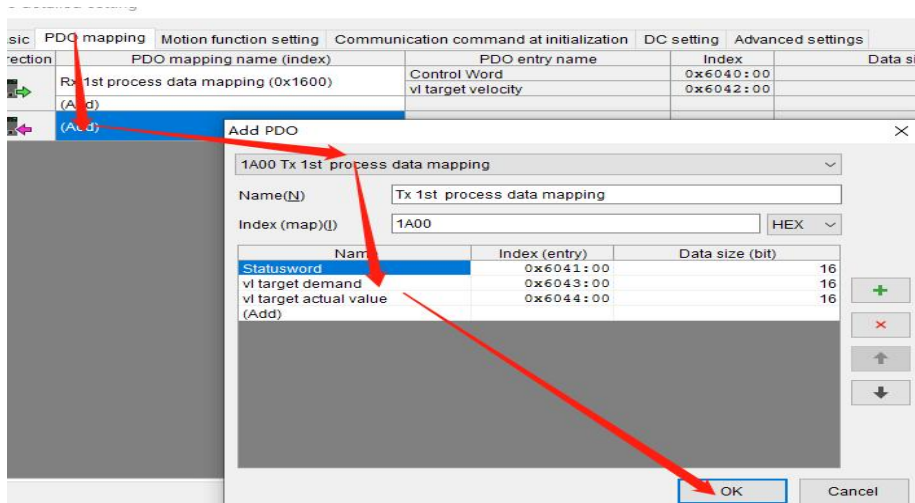
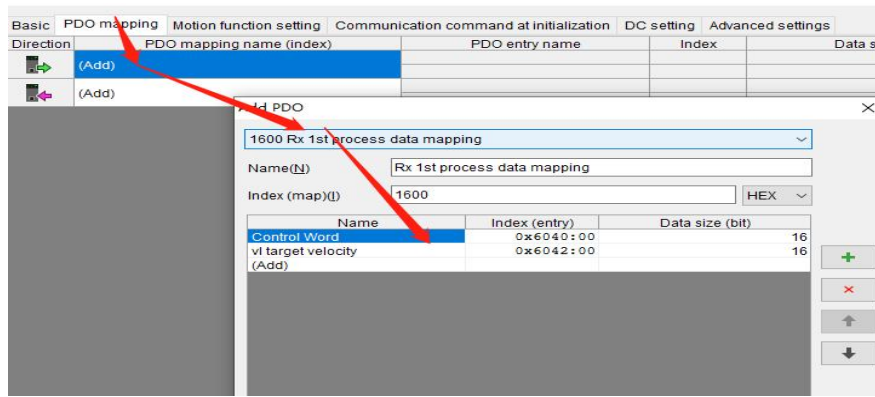

6) Activate configuration

After adding the object dictionary, download the program . After downloading the program, power on the PLC again. When the lower computer PLC turns green, it indicates that the activation is successful.

7) Add Group U parameters to the PDO.

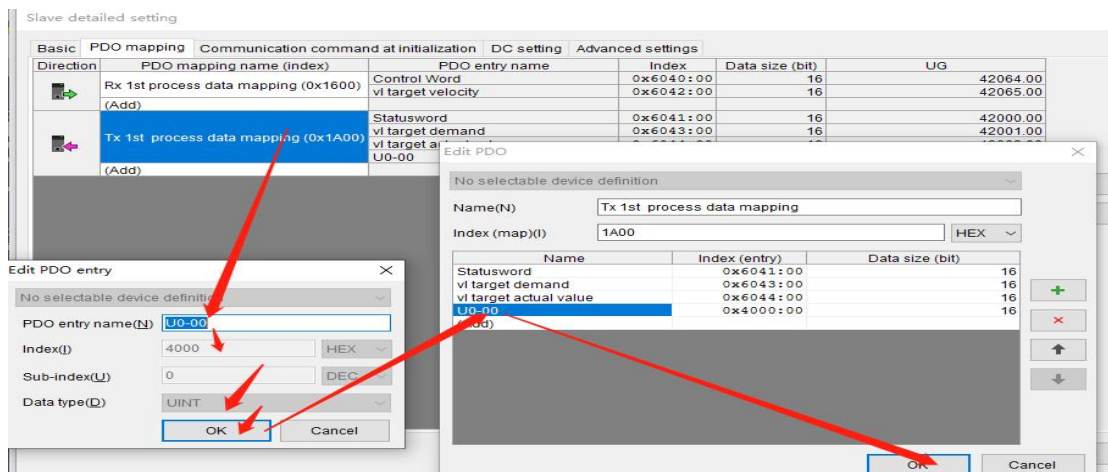

8) PDO data read/write(enable and speed setting)

The following figure shows the register configuration of the object dictionary. Switch the controller to online

mode after configuration, as shown in the following figure:

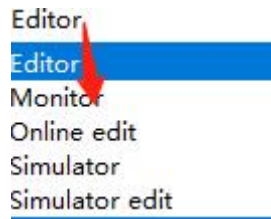

The following figure shows the mapping address of the object dictionary:

Detailed setting

Section	PDO mapping name (index)	PDO entry name	Index	Data size (bit)	JG
Rx 1st process data mapping (0x1600)	(Add)	Control Word	0x6040:00	16	42064.00
		vl target velocity	0x6042:00	16	42065.00
Tx 1st process data mapping (0x1A00)	(Add)	Statusword	0x6041:00	16	42000.00
		vl target demand	0x6043:00	16	42001.00
		vl target actual value	0x6044:00	16	42002.00

Open the monitor , select the expansion unit buffer memory, find the mapping address, and directly operate the object dictionary.

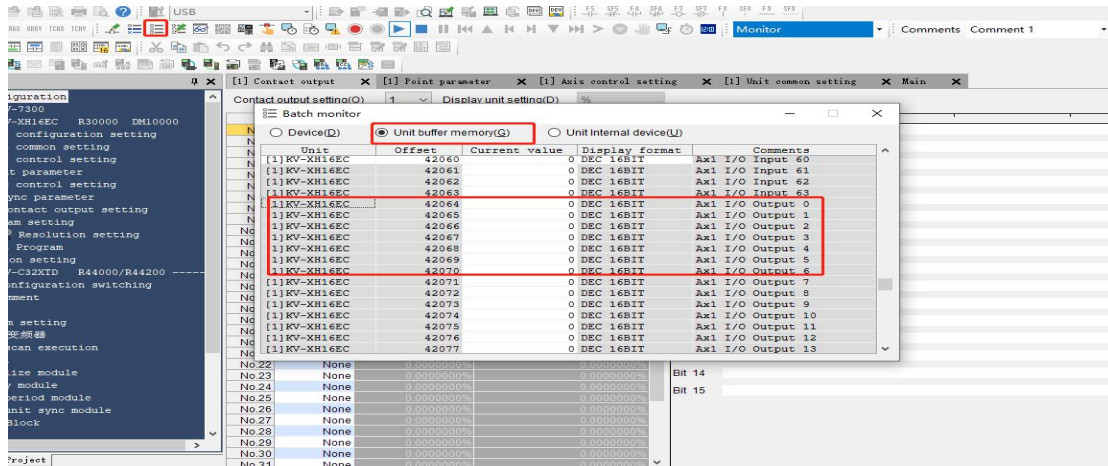

9) SDO data read/write

Read:

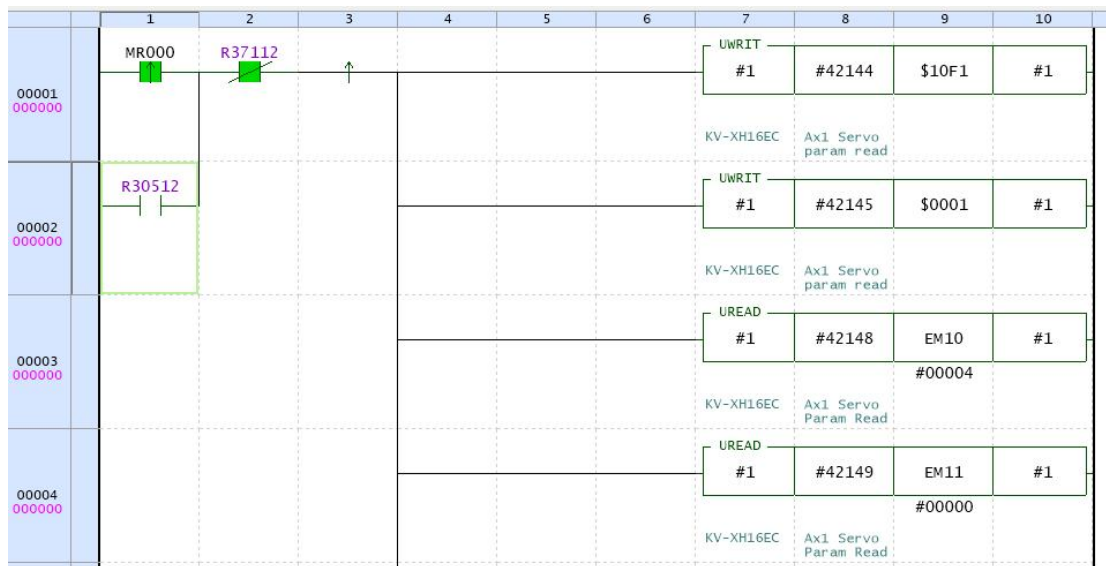

Write:

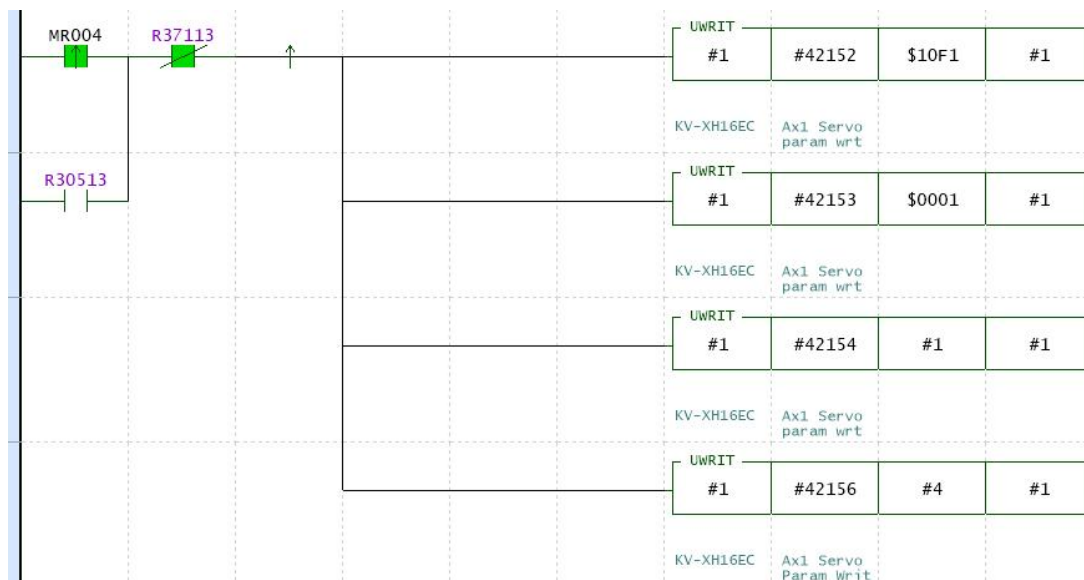

11. EtherCAT communication alarm code

When the EtherCAT communication is abnormal, the frequency converter panel displays an alarm with error Err44, and the object word 603Fh displays the error code “8xx”, which can be queried through U0-73 on the frequency converter panel. After the fault is rectified, use the bit7 of Controlword to reset the fault. The following table lists the detailed fault causes. (When the frequency converter itself alarms, that is, errors other than Err44, need to clear the alarm twice through the panel, once clear the alarm itself and once clear the communication alarm Err44. Through the bit7 of controlword, the reset and clearing fault only needs to be cleared once.)

Alarm code	Description	Reasons	Solutions
817	Incorrect ESM status request exception protection	Accept state transition requirements that cannot be transitioned from the current state: Init→SafeOP Init→OP PreOP→OP	Confirm whether the master station's state transition request is correct

Alarm code	Description	Reasons	Solutions
		ESM status after an error is reported: When the ESM status is Init, PreOP, or SafeOP, the ESM status remains. Change to SafeOP when the ESM status is OP ESC register AL Status Code:0011h	
818	No ESM required exception protection defined	Receive state transition requirements other than: 1:Request Init State 2:Request Pre-Operational State 3:Request Bootstrap State 4:Request Safe-operational State 8:Request Operational State ESM status after error reporting: stops at the current status when the current status isInit, PreOP, SafeOP, and changes to SafeOP when OP ESC register AL status code:0012h	Confirm whether the master station's state transition request is correct
819	Boot status request exception protection	Accept the following state transition requirements: 3:Request Bootstrap State ESM status after error reporting: init ESC register AL status code:0013h	Confirm whether the master station's state transition request is correct
822	Mailbox setting exception protection	The SM0/1 setting value of the mailbox is incorrect: The receiving and sending areas of the mailbox overlap with SM2/3, and the addresses of the receiving and sending areas are odd. The starting address of the mailbox is outside the range of SyncManager0:1000h~10ffh and syncmanager1:1200h~12ffh Incorrect setting of SyncManager 0/1 length (ESC registers: 0802h, 0803h/080ah, 080bh): SyncManager0: out of the range of 32~256byte SyncManager1: outside the range of 40~256byte Incorrect setting of control register (ESC register: 0804h/080ch) of SyncManager 0/1: Set other than 100110b to 0804h:bit5-0 Set other than 100110b to 080ch:bit5-0 ESM status after error reporting: init ESC register al status code:0016h	Set syncmanager correctly according to ESI file description
826	Synchronization error	Invalid synchronization signal ESC register AL status code:001ah	Check whether the network cable is disconnected or strongly disturbed
827	PDO watchdog abnormal protection	During PDO communication (SafeOP or OP status), bit10 of time 0220 (AL event request) is set through ESC register addresses 0400 (watchdog divider) and 0420 (watchdog time process data) without on. ESM status after error reporting: Safe OP	Confirm whether the sending time of PDO from the upper device is fixed (interrupted). Confirm that the PDO watchdog detection

Alarm code	Description	Reasons	Solutions
		ESC register al status code:001bh	delay value is too large. Confirm whether there is any problem with the wiring of EtherCAT communication cable and whether there is excessive noise on the cable.
829 /830	Syncmanager 2/3 setting exception protection	SM2/3 is set to an incorrect value The physical address of SM2/3 is set incorrectly (ESC register: 0810h/0818h): the receiving and transmitting area overlaps, overlaps with SM2/3, the starting address is an odd number, and the starting address completion address is outside the range SM2/3 length setting (ESC register: 0812h/081a) is different from RxPDO and TxPDO The control register (ESC register: 0814h/081ch) of SM2/3 is set incorrectly ESM status after error reporting: PreOP ESC register al status code:001dh/001eh	Set syncmanager2/3 correctly according to ESI file description
831	PDO watchdog setting abnormal protection	PDO watchdog setting error The PDO watchdog trigger is valid (SyncManager: bit6 of register 0804h is 1), and the set value of PDO watchdog detection timeout value (registers 0400h, 0402h) does not meet the "communication cycle *2" condition ESM status after error reporting: PreOP ESC register AL status code:001fh	Correctly set the watchdog detection timeout value
836	TxPDO distribution abnormal protection	The data size of TxPDO mapping exceeds 24 bytes ESM status after error reporting: PreOp ESC register Al status code:0024h	Confirm that the data size of TxPDO mapping is set within 24 bytes
837	RxPDO distribution abnormal protection	The data size of RxPDO mapping exceeds 24 bytes ESM status after error reporting: PreOp ESC register Al status code:0025h	Confirm that the data size of RxPDO mapping is set within 24 bytes
844	Synchronous signal abnormal protection	After the synchronization processing is completed, the interrupt processing occurs above the set threshold according to SYNC0 or IRQ ESM status after error reporting: SafeOP ESC register al status code:002Ch	Confirm the setting of DC and whether the propagation delay compensation and deviation compensation are correct.
845	PLL does not complete abnormal	1s after synchronous processing, the phase combination (PLL locking) of master station and slave station still cannot be completed	Confirm the setting of DC

Alarm code	Description	Reasons	Solutions
	protection		
848	DC setting abnormal protection	The setting of DC is wrong. Bit2-0 of ESC register 0981h (activation) is set to a value other than the following: bit2-0=000b , bit2-0=011b ESM status after error reporting: PreOp ESC register al status code:0030h	Confirm the setting of DC
850	PLL abnormal protection	ESM status refers to the situation that the communication and servo phases (PLL locking) do not match under SafeOp or OP status ESM status after error reporting: SafeOp ESC register al status code:0032h	Confirm the setting of DC and whether the propagation delay compensation and deviation compensation are correct.
853	Synchronization cycle setting abnormal protection	Set unsupported synchronization cycle: The set value of synchronization cycle is beyond 500us, 1ms, 2ms and 4ms ESM status after error reporting:PreOP ESC register AL status code: 0035h	Set the synchronization period correctly
870	Data frame loss alarm	Data frame loss	<ol style="list-style-type: none"> 1. Check whether the baud rate set in P9-02 matches the communication card. The default baud rate of the general machine is 06. 2. When setting ECAT communication parameters, power on again after modification, otherwise data frame loss may occur. 3. After the firmware of the communication card or frequency converter is updated, it needs to be powered off and restarted. 4. Check whether the communication card and the inverter backplane are properly inserted, or whether there is interference at the interface.
880	Internal	Expansion card and frequency converter failed to	Check whether there are

Alarm code	Description	Reasons	Solutions
	communication failure	establish communication successfully.	foreign matters in the expansion card slot and whether the pins in the slot are intact.
881	Inverter not responding		Check whether the parameters of the inverter are correct.
890	Slave state machine error	When the frequency converter is running, the master station requests non OP status without first closing the slave station. Or the error code is displayed after the key is reset, indicating that the key has no permission to reset the error (it may be enabled by the master station)	Check whether it enters non OP state during operation. If the reset key cannot clear it, it is necessary to check that the master station is forcibly enabling the operation command.



Wechat ID

XINJE WUXI XINJE ELECTRIC CO., LTD.

No.816, Jianzhu West Road, Binhu District, Wuxi City, Jiangsu Province, China

Tel: 400-885-0136

Fax: 86-510-85111290

www.xinje.com